

LONGER

WT600-4F Peristaltic Pump Drive Operating Manual

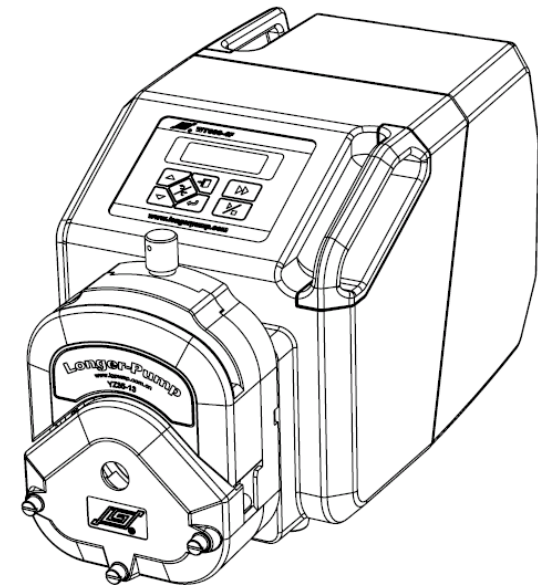

LONGER

Baoding Longer Precision Pump Co., Ltd.

Add: 3rd/4th Floor, Building 6B, University Science Park
Baoding National, High - Tech Industrial Development Zone
Baoding, Hebei, China 071051
Tel: 86 - 312 - 3110087 3138553
Fax: 86 - 312 - 3168553
E - mail: longer@longerpump.com
Http://www.longerpump.com

November 2019

WT600-4F Peristaltic Pump Drive

Baoding Longer Precision Pump Co.,Ltd.

⚠ Important Information:

- Please read operating manual carefully before operation.
- There is ground terminal on the case of pump which need to be grounded correctly to ensure the safety of operator.

⚠ Warning:

- Pump should be properly used within the range of technical specifications, or pump may be damaged.
- Pump drive is high precise and high IP rating product. Customer should not disassemble this product in order to avoid performance degradation or damage.
The sockets in the rear of pump should be waterproof and moisture proof and tighten the cap or plug in time.
- Tubing breakage result in fluid sprayed from pump. Use appropriate measures to protect operator and equipment. Please check the tubing frequently and change the tubing in time.
- Please shut down the power supply before installing the external control equipment or changing pump head and tubing.

Warranty:

The warranty period for this product is one year. If repair or adjustment is necessary within the warranty period, the problem will be corrected at no charge if it is not due to misuse or abuse on your part, as determined by the manufacturer. Repair costs outside the warranty period, or those resulting from product misuse or abuse, may be invoiced to you.

Table of Contents

Instruction -----1

Out Of Box Audit-----1

Drive Structure -----1

Usage & Operation -----2

 Operating Membrane-----2

 Basic Operation -----2

 Pump Head and Tubing-----3

Running Interface -----3

Operating Menu Diagram-----4

Pump Head & Tubing Selection-----4

Flow Mode Operation-----5

 Enter Flow Mode-----5

 Flowrate Setting -----5

 Flowrate Calibration-----5

 Flow Mode Operating Procedure-----6

Dispensing Mode Operation -----6

 Enter Dispensing Mode-----6

 Dispensing Volume-----6

 Copy No.-----7

 Flow Setting -----7

 Pause Time -----7

 Dispensing Calibration-----8

 Dispensing Mode Operating Procedure-----8

External Control Input Function -----9

 External Control Setting-----9

 External Control Plug and Socket -----9

 Footswitch-----11

 Back Suction Setting-----11

Communication Functions-----11

External Output Interface -----12

Maintenance -----13

Appendix-----13

Technical Specifications -----14

Instruction

WT600-4F is a high IP rating and high efficient pump with high-power DC brushless motor, it is suitable for working in dust and damp industrial environment. It delivers flowrates from 100 to 11000 ml/min and dispensing volume from 100ml to 999 liters when loading YZ35-13 or KZ35 pump head. WT600-4F adopts 128*32 LCD to display all the running information and parameters; it is easy to operate through membrane keypad or can be controlled through standard external control module and Rs485.

Out of box audit

Follow the below steps when opening the package:

1. Take out the pump and accessories from the carton;
2. Check the packing list to confirm complete accessories have been put in carton.

Drive Structure

Drive consist of motor driving circuit and controlling circuit, driving circuit is used to control the DC brushless of motor which can drive pump head and tubing to deliver fluid; controlling circuit is used to control all the functions of pump, including membrane, display, etc.

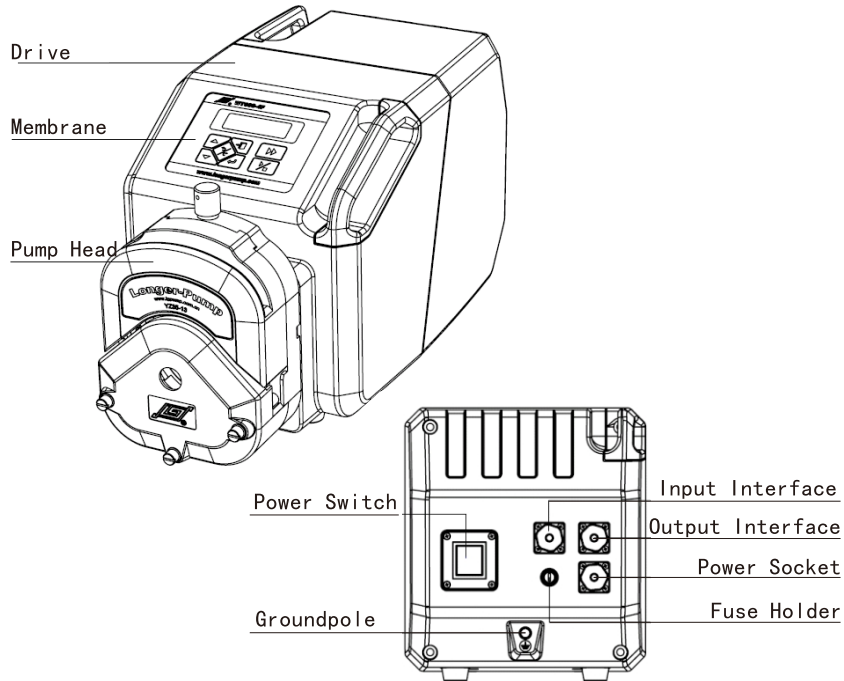

Usage and Operation

❖ **Operating Membrane**

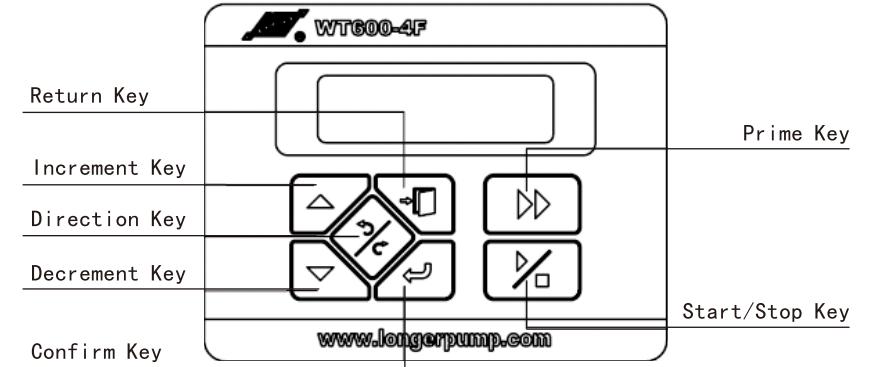

❖ **Basic Operation**

- **Start/Stop**
Press Start/Stop key to start or stop the pump. .
- **Direction**
Changing the rotation direction of pump by pressing Direction Key.
- **Full Speed**
Press Prime Key to run the pump at max. speed for the emptying, filling and rinsing operation in flow mode or the status that pump stops in dispensing mode. press Prime Key again the pump return to previous status. In prime mode, operator can check the parameter but some keys are invalid.
- **Return Key**
Function 1: In setting interface, cancel the current operation and return to upper menu.
Function 2: In dispensing mode, press Return Key to check current speed and dispensing time.
- **Increment Key and Decrement Key**
Function 1: In non- prime mode, press Increment Key or Decrement Key to increase or decrease the flow rate.
Function 2: In menu selection mode, press Increment Key or Decrement Key to set certain function or correct parameters.
- **Confirm Key:** Confirm the menu selection, function setting or revised parameters.

❖ **Pump Head and Tubing**

The usage of pump head and tubing is to deliver fluid, suitable pump heads and tubing for drive are as following:

Sheet 1: Suitable pum

Suitable Pump Head	Suitable Tubing	Flow Rate (ml/min)
YZ35-13 × (1, 2)	73#	100-6000(Single channel)
KZ35 × (1, 2)	82#	183-11000(Single channel)

❖ **Flow Display**

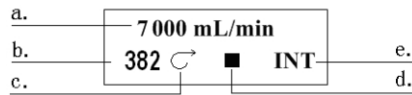

❖ **Dispensing Display**

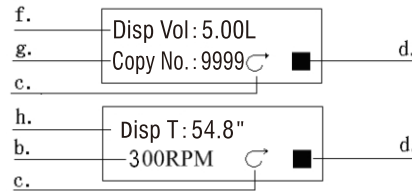

Dispensing mode have two kind of display mode, the first mode is to display dispensing volume and Copy No. the second mode is to display Running time and current speed. it can switch display mode by pressing Return Key.

- a. Currently flow rate: Display current flow rate, press Increment Key or Decrement Key to adjust the flow rate.
- b. Current speed: Display current speed, the speed will be changed when adjusting flow rates.
- c. Running direction: Indicate the rotation direction of pump.
- d. Running state: The symbol of **▶** means pump runs, the symbol of **■** means pump stops, the symbol of **▨** mean pump pauses, pumps can be start or stop by pressing Start/Stop Key.
- e. Control mode: 'INT' means pump is under internal control mode; 'V' means pump is controlled by remote control of analog voltage signal; 'mA' means pump is controlled by remote control of analog current signal; 'Hz' means pump is controlled by remote control of pulse signal, 'OFF' means the external control function is turned off by menu setting.
- f. Dispensing volume: Display the liquid need to be dispensed in dispensing mode.

- g. Copy No.: Display copy number in dispensing mode.
- h. Running time: In dispensing mode, display the required time to dispense volume each time. When the dispensing procedure starts, the dispensing time will be counted down. Adjust the flow rates to change the dispensing time in dispensing setting interface.

Operation Menu Diagram

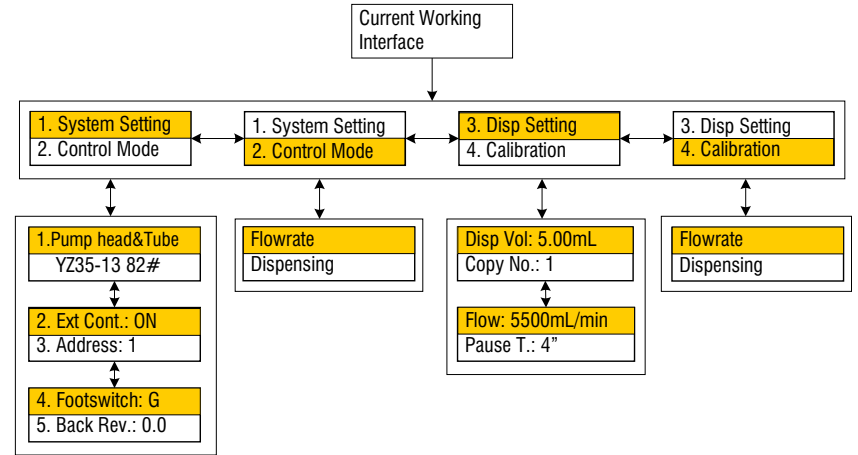

Pump Head & Tubing Selection

❖ **Pump Head Selection**

Enter 'Pump head & Tubing' interface, press 'Confirm Key' to enter pump head selection interface, press 'Increment Key' or 'Decrement Key' to select pump head, press 'Confirm Key' to save the selection or press 'Return Key' to cancel the setting, return to previous menu.

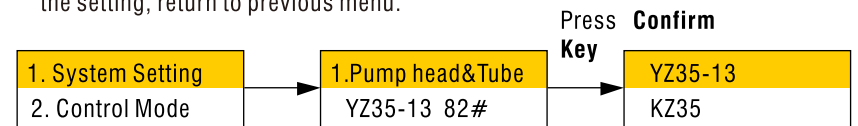

❖ **Tubing Selection**

Follow the below diagram, after choosing the suitable pump head, press 'Confirm Key' to enter 'Select Tubing' interface, press 'Increment Key' or 'Decrement Key' to choose suitable tubing, press 'Confirm Key' to save the selection or press 'Return Key' to cancel the setting, return to previous menu.

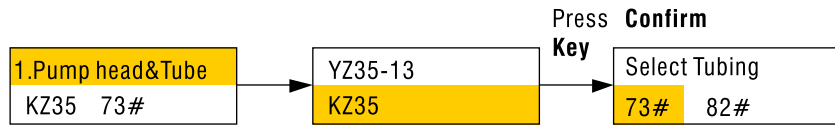

Flow Mode Operation

❖ Enter Flowrate Mode

Follow below diagram, enter 'Control Mode' interface, press 'Increment Key' or 'Decrement Key' to highlight 'Flowrate', press 'Confirm Key' to save the setting or press 'Return Key' to cancel the setting and back to previous menu.

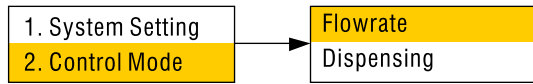

❖ Flowrate Setting

In 'Flowrate' mode, press 'Increment Key' or 'Decrement Key' to change the flow rates of the pumps.

❖ Flowrate Calibration

■ Calibration Time Setting

Follow the below diagram, enter 'Calibration' interface under flowrate mode, press 'Increment Key' or 'Decrement Key' to adjust testing time, the range of testing time is from 30 seconds to 1800 seconds, press 'Confirm Key' to save the setting or press 'Return Key' to cancel the setting and back to previous menu.

■ Calibration Procedure

Press 'Start/Stop Key' to start flow calibration, the screen will display 'Dispensing Time' and 'Actual Volume'; 'Dispensing Time' will count down until the procedure finish. Press 'Increment Key' or 'Decrement Key' to input actual volume, press 'Confirm Key' to save the setting. This procedure can be repeated in order to get a more accurate result.

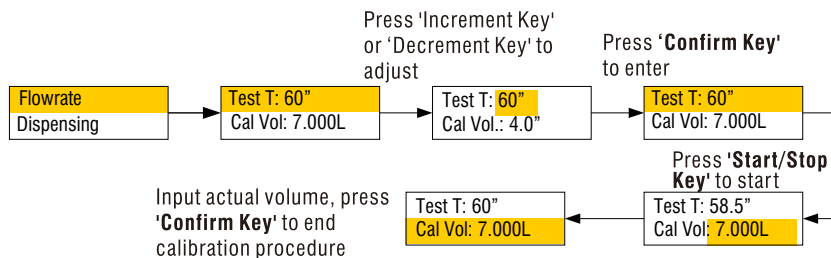

■ Fast Calibration

If the actual volume is known in advance, enter the calibration interface input the actual volume directly.

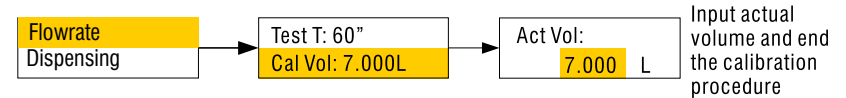

❖ Flow Mode Operating Procedure

Follow the below diagram, enter 'Control Mode' interface, press 'Increment Key' or 'Decrement Key' to choose 'Flowrate', press 'Confirm Key' to save the setting or press 'Return Key' to cancel the setting and back to pervious menu.

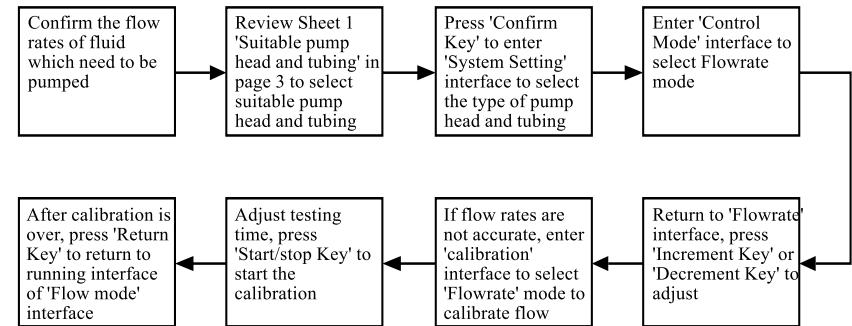

Dispensing Mode Operation

❖ Enter 'Dispensing Mode'

Follow the below diagram, enter 'Control Mode' interface, press 'Increment Key' or 'Decrement Key' to choose work mode, press 'Confirm Key' to save or press 'Return Key' to cancel setting and back to previous menu.



❖ Dispensing Volume

Follow the below diagram, enter 'Dispensing' interface, press 'Increment Key' or 'Decrement Key' to set the dispensing volume, press 'Confirm Key' to save or press 'Return Key' to cancel setting and back to previous menu.

💡 The running time will be changed when changing dispensing volume.

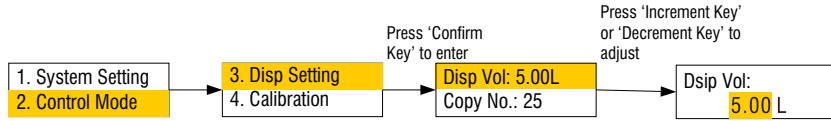

❖ Copy No.

- The total dispensing number in dispensing mode. Its range is from 0 to 9999.
- Enter 'Copy No.' interface, press 'Increment Key' or 'Decrement Key' to set the 'Copy No.' press 'Confirm Key' to save the setting or press 'Return Key' to cancel the setting and back to pervious menu.
- If the copy no. is '0', the dispensing process of the pump will continue until pressing Start/stop or shut off the pump to stop dispensing.

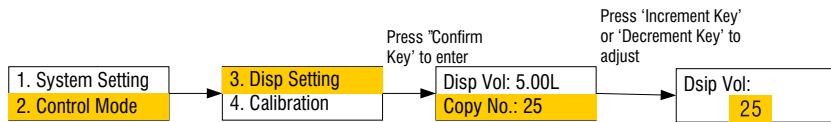

❖ Flow Setting

- 'Flow' in dispensing mode means the flowrate when dispensing liquid, dispensing time will be changed when adjusting the 'Flow'.
- Enter 'Flow' interface following the below diagram, press 'Increment Key' or 'Decrement Key' to adjust flow rates, press 'Confirm Key' to save the setting or press 'Return Key' to cancel the setting and back to previous menu.

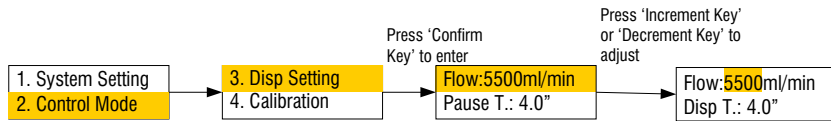

❖ Pause Time

- Pause Time: Time interval between two adjacent dispensing operations.
- Enter 'Pause Time' interface following the below diagram, press 'Increment Key' or 'Decrement Key' to adjust the pause time, press 'Confirm Key' to save the setting or press 'Return Key' to cancel the setting and back to previous menu.

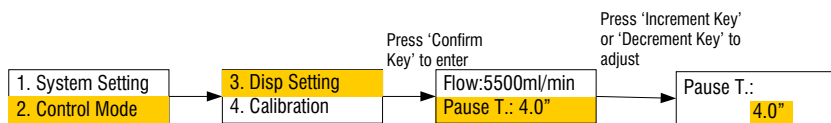

❖ Dispensing Calibration

- All the parameters can not be revised under dispensing calibration mode, the default parameters are these parameters under dispensing mode.
- Follow the below diagram, enter 'Calibration' interface.
- Press 'Start/stop Key' to start calibration, the screen will display 'Running Time' and 'Actual Volume', running time will count down until to end.
- Press 'Increment Key' or 'Decrement Key' to input actual volume, press 'Confirm Key' to save the setting or press 'Return Key' to cancel the setting and back to previous menu.

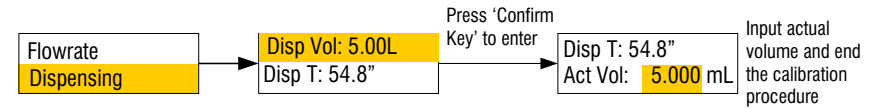

- If the actual volume is known in advance, enter the calibration interface and input the actual volume directly.

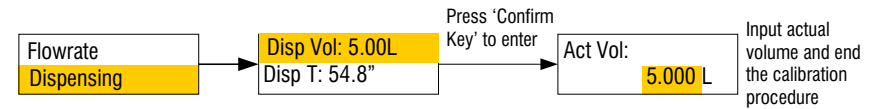

❖ Dispensing Mode Operating Procedure

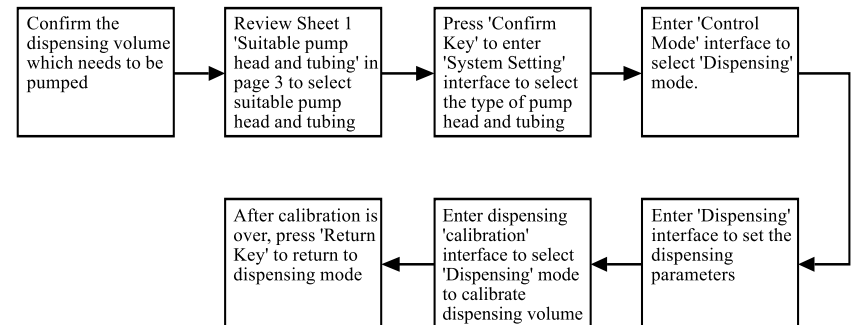

External Control Input Function

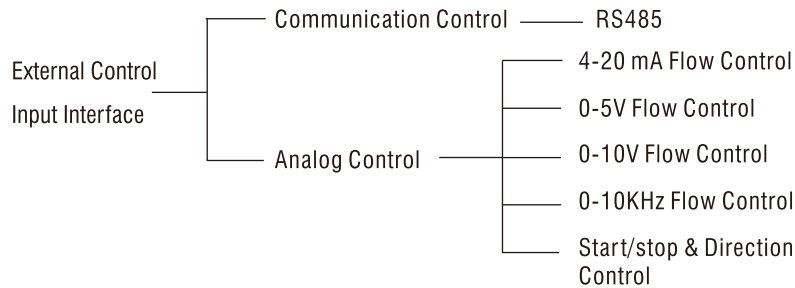

Pump can be controlled by communication control and analog control through external control input interface, analog control can control the flow, start/stop, direction; communication control can control all the functions of pump, including start/stop, direction, flow, calibration, functions setting, parameters revised, etc. Note: The defaulted external control mode of pump is 4-20mA. Customer need to specify the external control mode if they need other type of external control mode.

❖ External Control Setting

Enter external control 'Ext Cont' interface, press 'Increment Key' or 'Decrement Key' to select necessary status, press 'Confirm Key' to save the setting or press 'Return Key' to cancel the setting and back to upper menu.

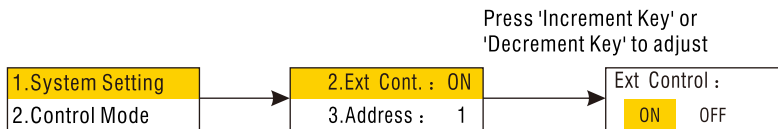

❖ External Control Plug and Socket

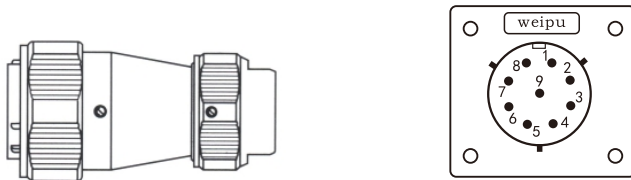

Water-Proof Aviation Plug

Terminal Drawing of Water-Proof Aviation Socket

Terminal Definition of Standard External Control Module

- Terminal 1:** Control signal input end, used for 4-20 mA, 0.0833-5V, 0.166-10V (or 0.167-10 kHz) signal input to control the flow rates of pump.
- Terminal 2:** Start/stop control input end, the pump runs when terminal 2 is disconnected or input low TTL; the pump stops when terminal 2 is input high TTL (5V)
- Terminal 3:** Direction control input end, the pumps runs clockwise when terminal 3 is disconnected or input low TTL; the pump runs count-clockwise when terminal 3 input high TTL (5V).
- Terminal 4:** Analog ground (AGND) in 4-20 mA, 0.0833-5V, 0.166-10V external control modules.
- Terminal 5:** Voltage or current input signal identification, terminal 5 is disconnected when input voltage signal; terminal 5 is short-circuit with terminal 4 when input current signal.
- Terminal 6:** External control identification signal which need to be short-circuit with terminal 4.
- Terminal 8:** Frequency input identification, terminal 8 is short-circuit with terminal 4 when input 0.167-10 KHz frequency input signal.
- Terminal 9:** The COM (public end) of external input signal of start/stop, direction and frequency input signal.

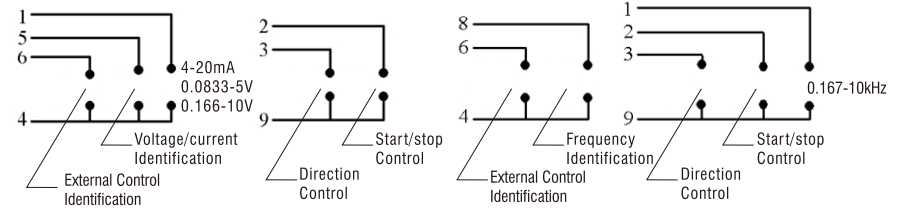

4-20mA/0.0833-5V/0.166-10V Interface Wiring Diagram

0.167-10kHz interface Wiring Diagram

💡 External control interface adopts Water-Proof Aviation Socket, operator should tighten the gap of Aviation Socket in order to prevent the pump from water or moisture.

❖ **Footswitch**

- Connect with external control interface to control the Start/Stop of the pump; flow and direction are controlled by membrane.
 - Footswitch has two kind of working mode.
Trigger: The status of start/stop will be changed when footswitch is pressed once.
Gated: The pump will maintain one state when footswitch is pressed; the pump maintains another state when footswitch is released.
- Footswitch Setting
- Enter 'Footswitch' interface, press 'Increment Key' or 'Decrement Key' to select suitable mode, press 'Confirm Key' to save the setting or press 'Return Key' to cancel setting and back to previous menu.

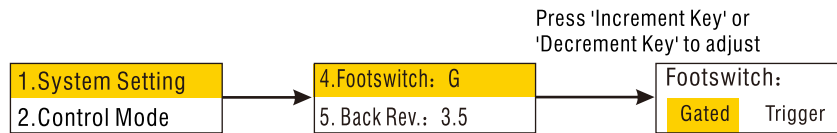

- 💡 1. This pump automatically identifies external control footswitch. The 'Start/Stop' key is invalid when pump is connected with footswitch, this setting don't have any relation with external setting.
- 2. Footswitch is optional accessory; it can only control the start/stop of the pump. Customer need to order it separately.
- 3. External control footswitch should be pulled out to recover the function of membrane if external control is not necessary. The gap of external control socket should be tightened.

❖ **Back Suction Setting**

Enter 'Back Suction Setting' interface, press 'Increment Key' or 'Decrement Key' to choose the back suction revolution.

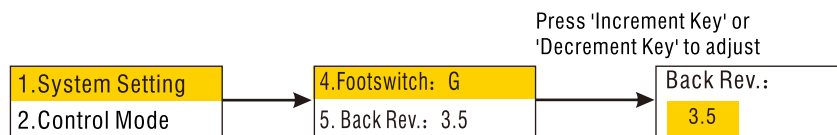

Communication Functions

This pump can be connected with the control computer (computer, PLC, SCM) through RS485 serial communication interface to realize all the functions including Start/Stop, Direction, flowrates, function setting, parameters revised, etc.

❖ **Pump Address**

- When control computer control several pumps through RS485, it must identify each pump's I.D. This pump I.D. should be unique. It is the identification of each pump. One control computer can control 30 pcs WT600-4F through RS485 in same time.
- Setting Pump Address: Enter pump address interface, press 'Increment Key' or 'Decrement Key' to adjust pump address (1-30), press 'Confirm Key' to save the setting or press 'Return Key' to cancel setting and back to previous menu.



❖ **Communication Wiring**

Communication interface use 'External Control Socket' is as following:

- Terminal 1 Rs485 A
- Terminal 2 RS485 B
- Terminal 3 RS485 COM

💡 Customer need to order RS232/RS485 converter separately.

External Output Interface

- Pump is equipped with output port in order to monitor the status of pump. Output signal adopts optoelectronic isolation circuit. A pull-up resistor and power supply are needed when using, the drive current is between 5 to 10 mA.

- External control interface adopts 5 pins aviation socket, all the pins defined as following.

Terminal 1: Start/stop status output, pump output low TTL when pump runs; pump output high TTL when pump stops.

Terminal 2: Direction status output, pump output low TTL when pump runs clockwise; pump output high TTL when pump run count clockwise.

Terminal 3: Speed frequency output, speed 10-600 rpm are corresponding to 125-7500 Hz.

Terminal 4: The COM of other pins.

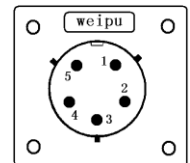

Maintenance

- When the pump is idle, we recommend customer to release the tubing from pressure. This helps to protect the tubing from unnecessary strain and prolongs its service life.
- Keep rollers clean and dry. This will prolong the service lives of tubing and pump head.
- The surface of drive and the pump head are not organic solvent and aggressive liquids resistant. Please pay attention when using.

 Please contact Longerpump company by email longer@longerpump.com if customers need to know more information about the operation of WT600-4F.

Appendix

Pump Configuration Sheet

Number	Name	Type	Quantity	Remarks
1	Drive	WT600-4F	1	Standard Accessory
2	Power Cord	Special National Plug 1.8m	1	Standard Accessory
3	Fuse	3A/250V	2	Standard Accessory
4	Plug	5 Pins Aviation Plug	1	Based on customer requirement
5	Plug	9 Pins Aviation Plug	1	Based on customer requirement
6	Pump Head	YZ35-13		Based on customer requirement
7	Pump Head	KZ35		Based on customer requirement
8	Tubing	73#		Based on customer requirement
9	Tubing	82#		Based on customer requirement
10	Communication Module	NWE485-A		Based on customer requirement
11	Operation Manual	1	12	Qualification Certificate 1

Technical Specifications

❖ **Main Functions**

Suitable Pump Head	YZ35-13, KZ35
Operating Mode	Press membrane to operate this pump
Direction Control	CW & CCW, Reversible
Prime	Full speed for fast filling and emptying
Back Suction	Prevent liquid from dripping
Display	128×32 Graphic LCD displays all the information
External Control Input	Control Start/Stop, Direction and flow rates under flow rates mode
Footswitch	Control Start/Stop of the pump
External Control Output	Output the signals of Start/Stop, direction and speed
Communication	Communicate with control computer
Flowrate Functions	Deliver fluid at set flow rates
Dispensing Function	Set dispensing volume, copy number and pause time, etc
Memory Function	Store all the running information automatically
Calibration	Acquire higher accuracy
Cooling Mode	Heat-emitting fan

❖ **Specification**

Flow Rates	100 – 11000 (ml/min)
Dispensing Volume	100ml to 999 L
Speed	10 – 600 (rpm)
Copy No.	0 – 9999, '0' means continuous running
Pause Time	1 second to 99.9 minutes
Back Suction	0 to 9.9 revolutions (precision is 0.1 revolution)
Calibration Time	30 to 1800 seconds
External Control Input	Control Start/Stop, Direction, Flow (0.0833 – 5V, 0.166 – 10V, 4 – 20 mA, 167 – 10kHz, only one mode need to be chosen when ordering pump)
External Control Output	Start/Stop, direction, frequency 125-7500 Hz
Communication	RS485
Power Supply	AC176 – 264V 50/60Hz
Power Consumption	<300W
Operating Conditions	Temperature: 0 – 40 °C, Relative Humidity: <100%
Dimension (L×W×H)	293.2×185×180.5
Weight	5.2 kg
IP Rating	IP65

