

LONGER

BT100-1L Peristaltic Pump Drive

**BT100-1L**  
**Peristaltic Pump Drive**  
Operating Manual

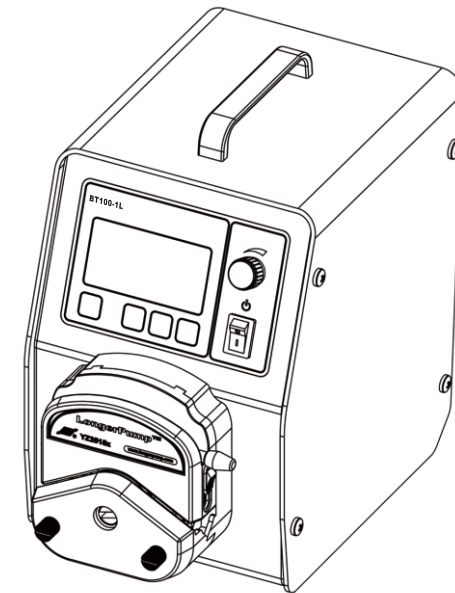

LONGER

**Baoding Longer Precision Pump Co., Ltd.**

Add: 3rd/4th Floor, Building 6B, University Science Park  
Baoding National, High - Tech Industrial Development Zone  
Baoding, Hebei, China 071051  
Tel: 86 - 312 - 3110087 3138553  
Fax: 86 - 312 - 3168553  
E - mail: [longer@longerpump.com](mailto:longer@longerpump.com)  
[Http://www.longerpump.com](http://www.longerpump.com)

Baoding Longer Precision Pump Co.,Ltd.

**⚠ IMPORTANT INFORMATION:**

Please read operation manual carefully before operation.

**⚠ WARNINGS:**

- Tubing breakage may result in fluid being sprayed from pump. Use appropriate measures to protect operator and equipment. Please check the tubing frequently and change the tubing in time.
- If the power line or the plug is worn or damaged please pull out the plug (Hold the plug not the power line when pulling out).
- Please shut down the power supply and pull out the plug when meet below circumstances (Hold the plug not the power line when pulling out).  
The fluids splash on the body of the pump.  
You think the pump needs to be maintained or repaired.
- Please shut down the power supply before install the external control equipments.

**Table of Contents**

<b>Introduction</b> .....	1
<b>Operation Panel</b> .....	2
<b>Basic Operation</b> .....	2
<b>Running Interface</b> .....	3
<b>Function Setting</b> .....	3
Flow Rates Calibration .....	4
Pump Head Selection .....	5
Tubing Diameter Selection .....	5
Pump ID. ....	6
Footswitch .....	6
Remote Control .....	7
<b>Acceptable Pump Heads and Tubing</b> .....	7
<b>Remote Control Function</b> .....	8
<b>Optional Accessories</b> .....	10
<b>Maintenance</b> .....	10
<b>Warranty</b> .....	10
<b>Technical Specifications</b> .....	11

**Introduction**

The max. output torque of BT100-1L drive is 1.65 N·M. It can connect 4 sets YZ series pump heads or 24 channels DG pump heads or 8 channels DG15 cassette pump head. 128 x 64 graphic LCD displays running menus and parameter setting menus. The flow rate and the speed (rpm) can be displayed in the same screen. The display interfaces are friendly. It has flow rate calibration function to make the flow rate more accurate. It has many control modes. The external control can be realized through standard external interface or 485 communication interface.

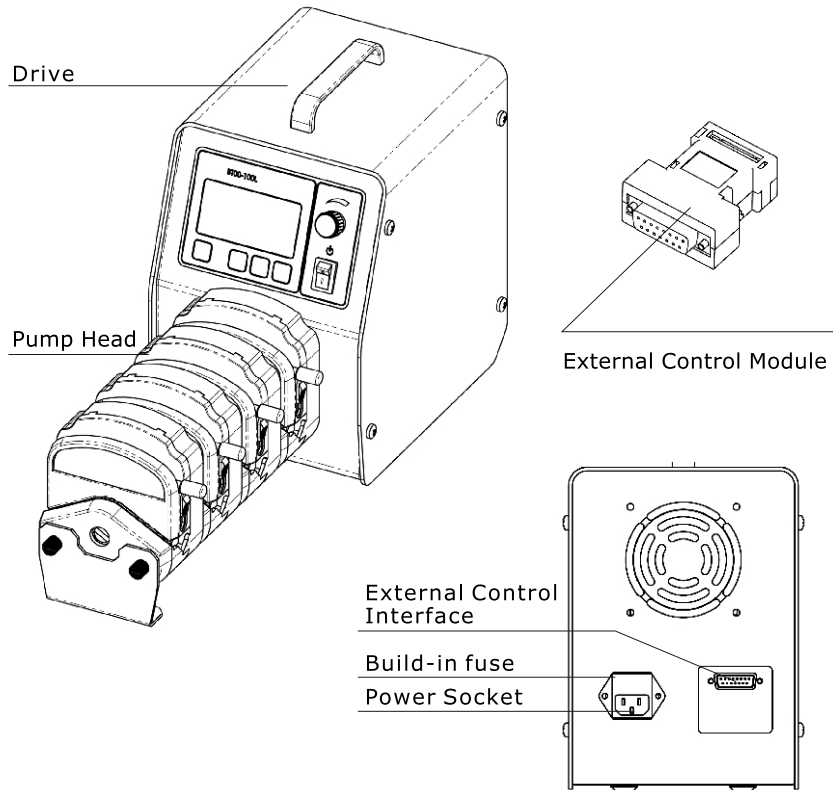

**Reference:**

For detail information about external control function please see page 8.

**Operation Panel**

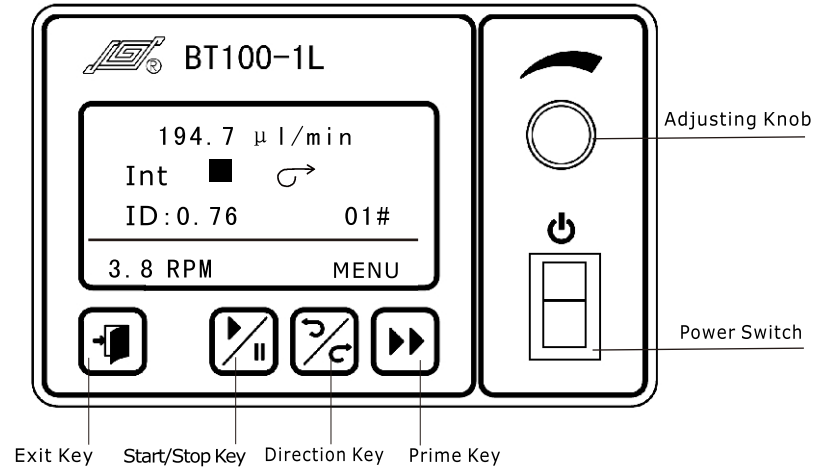

**Basic Operation**

- **Start/Stop Key**  
Press the **Start/Stop Key** to start or stop the pump.
- **Direction Key**  
Press the **direction key** to change the rotation direction of the pump.
- **Adjusting Knob**  
Function 1: Adjust the flow rates or speed in running state.  
Function 2: In menu selection state, when the pump is idle press the **adjusting knob** for confirmation and turn the **adjusting knob** for selecting and setting the menus.
- **Prime Key**  
In common state, press the **Prime Key** to enter prime state when the pump runs at full speed for emptying, filling and rinsing operation; Press the **Prime Key** again to return to common state. In prime state, other keys are invalid.
- **Exit Key**  
Cancel current operation and return to previous menu.

**Running Interface**

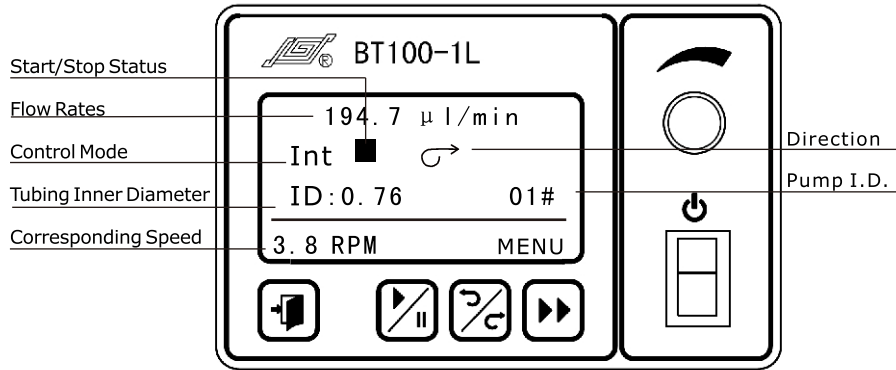

**Function Setting**

In "Running Interface", press the **adjusting Knob** to enter function setting interface. Turn the **adjusting knob** to select 6 kinds of function setting interface: 1. Calibration; 2. Pump Head; 3. Tubing ID; 4. Pump I.D.; 5. Footswitch; 6. Remote Control.

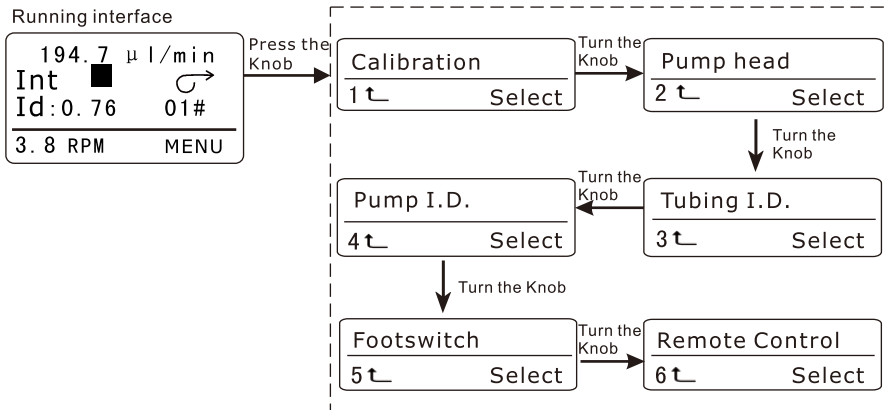

The symbol of "⏪" in the interface means you can press the **Exit Key** to return to the previous interface.

**❖ Flow Rates Calibration**

- Calibration is needed in below situations:
  1. Use the pump the first time;
  2. Change the tubing;
  3. Change the pump head;
  4. Set new flow rate;
  5. Operate condition changes.
- Make sure that the pump head and the tubing correspond to the setting of the menu.

In "Calibration" interface, press the **Adjusting Knob** to enter flow rate calibration performing interface.

1. Flow: the current setting flow rate.
2. Vol: the total transferring volume for this test. The value equals to the arithmetic product of Flow and Time.
3. Time: test time. Set the time through turning the **Adjusting Knob**. The setting range is 0.5-30 minutes.

Press the **Start/Stop Key** to begin the test. The time counts down. The pump stops automatically when the time is up. Measure the actual volume and then turn the **Adjusting Knob** to input the actual volume. Press the **Adjusting Knob** to save the calibration value and quit to "Calibration" interface. Press the **Exit Key** to cancel the setting.

💡 Press the **Start/Stop Key** when the testing is on to cancel this test. Re-press the Start/Stop Key to start the test from beginning.

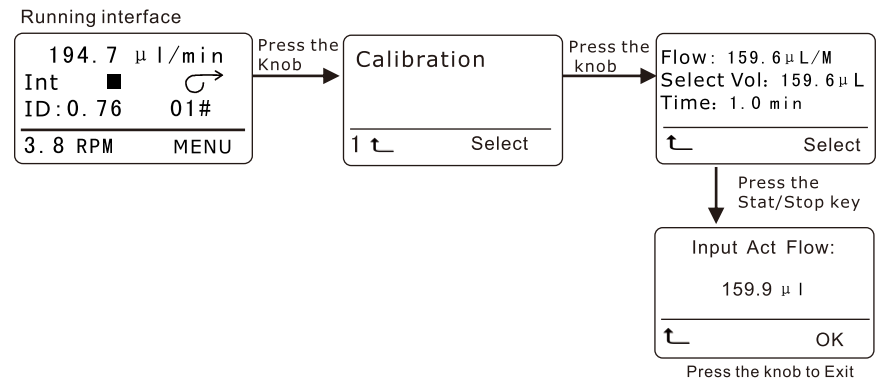

❖ Pump Head Selection

- Make sure the pump head corresponds to the setting of the menu. In "Pump Head" interface, press the **Adjusting Knob** to enter pump head selection setting interface. Turn the **Adjusting Knob** to select the corresponding pump head. Press the **Adjusting Knob** to save and quit. Press the **Exit Key** to cancel the setting and return to "Pump Head" interface.

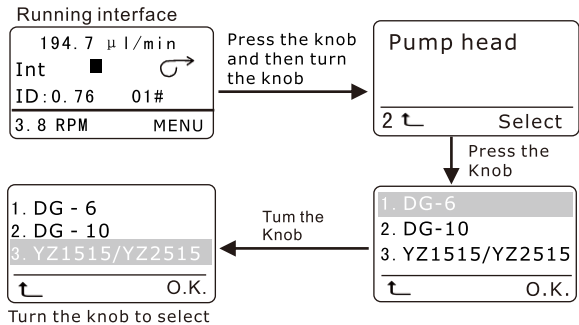

Turn the knob to select

❖ Tubing Diameter Selection

- Make sure the tubing inner diameter corresponds to the setting of the menu.
- In "Tubing ID" interface, press the **Adjusting Knob** to enter tubing selection setting interface. Different pump head corresponds to different tubing inner diameter. Turn the **Adjusting Knob** to select the corresponding tubing. Press the **Adjusting Knob** to save and quit. Press the **Exit Key** to cancel the setting and return to "Tubing ID" interface.

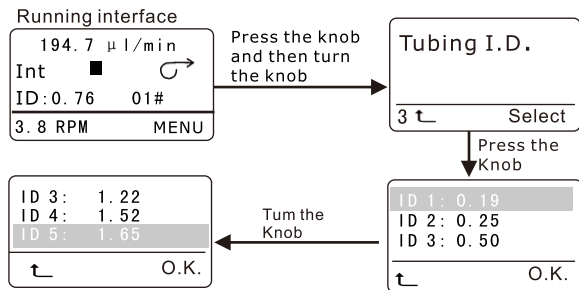

Turn the knob to select

💡 Reset the tubing inner diameter after changing the pump head setting.

❖ Pump I.D.

- When control computer controls many pumps through RS485 interface, it must identify each pump's I.D.. This pump I.D. should be unique. It's the identification of this pump.
- In "Pump I.D." interface, press the **Adjusting Knob** to enter pump I.D. setting interface. Turn the **Adjusting Knob** to select the corresponding number. Press the **Adjusting Knob** to save and quit. Press the **Exit Key** to cancel the setting and return to "Pump I.D." interface.

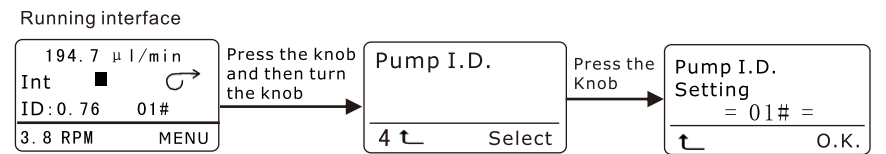

Turn the knob to select

❖ Footswitch

- Set footswitch working mode.
  1. Gated: The pump runs as long as the footswitch is pressed.
  2. Trigger: Press footswitch, the pump starts running; Press footswitch again, the pump stops.
- In "Footswitch" interface, press the **Adjusting Knob** to enter footswitch setting interface. Turn the **Adjusting Knob** to select the corresponding state. Press the **Adjusting Knob** to save and quit. Press the **Exit Key** to cancel the setting and return to "Footswitch" interface.

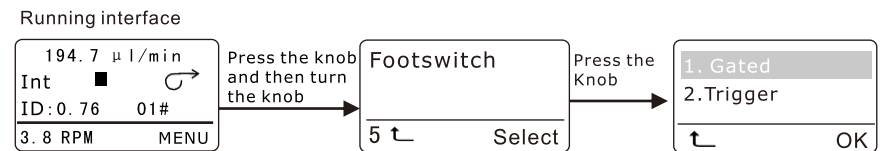

Turn the knob to select

💡 When the pump connects the footswitch, the **Start/Stop Key** on operating panel is invalid no matter the remote control is on or off.

❖ **Remote Control**

- Remote Control on or off setting.
  1. On: Remote control is permitted.
  2. Off: Remote control is forbidden.
- In "Remote Control" interface, press the **Adjusting Knob** to enter remote control setting interface. Turn the **Adjusting Knob** to select the corresponding state. Press the **Adjusting Knob** to save and quit. Press the **Exit Key** to cancel the setting and return to "Remote Control" interface.

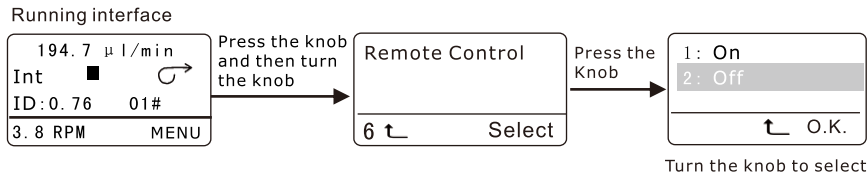

**Acceptable Pump Heads and Tubing**

Drive	Pump Head	Tubing	Flow Rates (Per Channel)
BT00-100L	DG Series 24 Channels (6 rollers,10 rollers)	Inner diameter ≤2.4mm Wall Thickness ≤1.0mm	0.02~22.60
	4-YZ1515x YZ1515w	13# 14# 16# 25# 17# 18#	0.06~426.40
	4-YZ2515x	15# 24#	1.80~303.40
	DG15-48	Inner diameter ≤2.4mm Wall Thickness ≤1.0mm 13# 14#	0.06~48.730
	DG15-24	16# 25# 17#	0.67~348.80

**External Control Function**

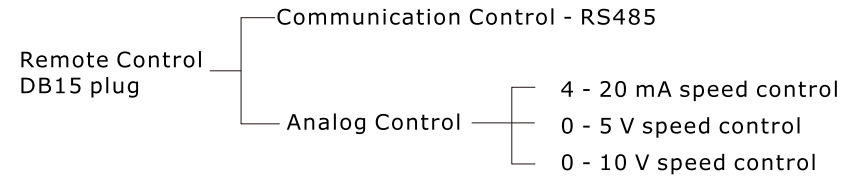

❖ **Communication Control**

The pump can connect to control computer (computer, PLC, SCM) through RS485 serial communication interface (shown as below). Please contact Longer Company for communication protocol.

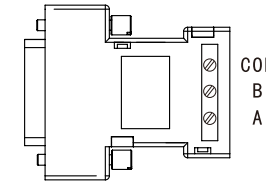

❖ **Analog Control**

Set the "Remote Control" in "on" state. External Control Module is shown as below.

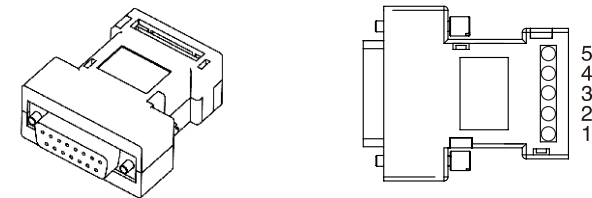

External Control Module

💡 Four kinds of standard external control module need to order separately according to special requirements.

- Terminal Definition of Standard External Control Module

- 1#** Analog speed control input, for external speed control in external control modules of 4 - 20 mA, 0 - 5V and 0 - 10 V.
- 2#** External start/stop control input. When connected to COM, the pump runs, when connected to high level, the pump stops.
- 3#** External cw/ccw control input. When connected to COM, the pump rotates cw, when connected to high level, the pump rotates ccw.
- 4#** Reference potential for 4 - 20 mA, 0 - 5V/10V speed control input.
- 5#** Reference potential for external cw/ccw, external start/stop input.

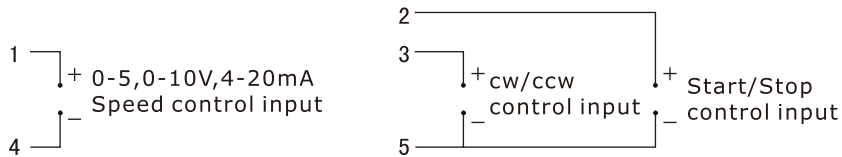

0 - 5V, 0 - 10V, 4 - 20mA External Control Module Wiring Diagram

**Optional Accessory**❖ **Footswitch**

Connect to the external control interface. Control the start and stop of the pump.



Footswitch is optional accessories. It can only control the start and stop of the pump. The speed and direction of the pump are controlled by the knob and switch on the operation panel.

**Maintenance**

- When the pump is idle, we recommend you to release the tubing from pressure. This helps to protect the tubing from unnecessary strain and prolongs its service life
- Keep rollers clean and dry. This will prolong the service lives of tubing and pump head.
- The surface of drive and the pump head are not organic solvent and aggressive liquids resistant. Please pay attention when using.



If a trouble happens, please contact us or our dealers.

**Warranty**

The warranty period for this product is one year. If repair or adjustment is necessary within the warranty period, the problem will be corrected at no charge if it is not due to misuse or abuse on your part, as determined by the manufacturer. Repair costs outside the warranty period, or those resulting from product misuse or abuse, may be invoiced to you.

## **BT100-1L OPERATING MANUAL**

### **Technical Specifications**

#### **❖ Functions**

Applicable Pump Head	DG Series, YZ Series, DG15 Series, 313D Series
External Control	Start/stop control, direction control, speed control (0 - 5V, 0 - 10V, 4 - 20mA optional)
Prime	For fast filling and emptying
Speed Control	Rotary coded switch adjustment
Display	Display flow rate and speed
Direction Control	cw and ccw reversible
Cooling Mode	Heat-emitting fan

#### **❖ Specifications**

Speed	1 - 100.0 rpm
Speed Precision	0.1 rpm
External Control Interface	External Control Start/Stop, direction, 0 - 5V/10V, 4 - 20mA
Communication Interface	RS485
Output Torque	1.6 N·M
Display Mode	128 × 64 graphic LCD display
Applicable Power	AC 220V ±10% 50Hz±1Hz AC 110V ±10% 60Hz±1Hz
Power Consumption	< 50 W
Operating Condition	Temperature 0 - 40°C Relative humidity < 80%
Drive Dimensions	(L × W × H) 202 × 160 × 239 (mm)
Drive Weights	5.34 kg
IP Rating	IP 31