

**Industrial Peristaltic Pump
G100-1J/G300-1E/G300-1J
Operating Manual**

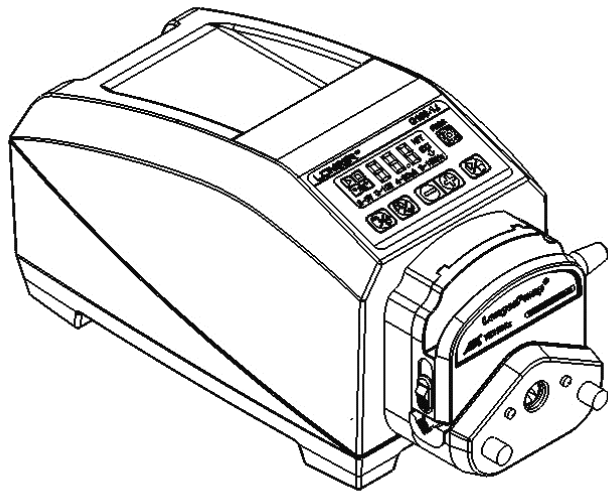

Content

1 General Information	01
1.1 Precaution	01
1.2 Warranty and Service	01
1.2.1 Warranty Service	01
1.2.2 Maintenance Service	02
1.2.3 Service Commitment	02
1.2.4 Dispute Settlement	02
1.3 Repair Notes	02
1.4 Contacts Information	02
2 Product Introduction	03
2.1 Main Features of G100-1J/ G300-1E/ G300-1J	03
2.2 Unpacking	03
2.3 System Structure	03
2.3.1 Peristaltic Pump Drive	04
2.3.2 Applicable Pump Head and Tubing, and Reference Flow Rate	04
2.4 Function & Specification	08
2.4.1 Main Functions	08
2.4.2 Specifications	08
3 System Installation	09
3.1 Installation of G100-1J/ G300-1E/ G300-1J	09
3.1.1 Outline Dimension of G100-1J/ G300-1E/ G300-1J	09
3.1.2 Fixing of G100-1J/ G300-1E/ G300-1J	10
3.1.3 Grounding of G100-1J/ G300-1E/ G300-1J	11
3.2 Installation of Pump Head	12
3.2.1 Installation of Pump Head YZ1515x/YZ2515x/YZII15/YZII25	12
3.2.2 Installation of Pump Head FG15-13/FG25-13	13
3.2.3 Installation of Pump Head DMD15-13 and Tubing	13
4 System Operation	15
4.1 Keypad and LCD	15
4.2 Basic Operation (Introduction about the keypads' functions)	15
4.3 Run Screen	16
4.4 Control Mode Introduction and Mode Switch	16
4.5 Parameter Settings	20
4.5.1 Pump State When Power Up	20
4.5.2 Automatic Keypad Lock	21
4.5.3 Trigger Model of External Start/ Stop Control	21
4.5.4 Communication Parameters through Keypad	22
4.5.5 Max Speed of External Signal Control	24
4.5.6 Trigger Mode of External Running Direction Control	25

- 4.6 External Signal Control** 26
 - 4.6.1 Definition of External Control Port 26
 - 4.6.2 Operating Steps for External Signal Control 27
- 4.7 Footswitch Control** 27
- 4.8 Communication Control** 27
 - 4.8.1 Communication Control Using Longer OEM Protocol 27
 - 4.8.2 Communication Control Using Modbus RTU Protocol 28
- Appendix 1 Longer OEM Protocol** 28
- Appendix 2 Modbus RTU Protocol** 30
- Appendix 3 Alarm** 31

1 General Information

1.1 Precaution

● The housing of the drive is provided with grounding terminal. In order to guarantee the operator's safety and improve the electromagnetic compatibility of the equipment, please ground the product reliably.

● This pump drive has high precision and high IP rating. Please do not disassemble, refit or maintain the product without permission, so as to avoid any damage or reduction to its performance.

● All ports at the end of the drive shall be protected against damp and water. Besides, the end caps or plugs shall be screwed up in time.

● If tubing leaks or bursts, fluid may spray from the tubing and pump head. Take reasonable practicable measures to ensure the operators' safety.

● Make sure fluid in the tubing has been drained out, no pressure in the pipeline and disconnect pump from mains power, while removing or replacing the tubing.

● Disconnect pump from the mains power before connecting the control signal wire.

● Do not touch the rotor while pump is running.

● Release the compression block when pump stop running for a long time to avoid tubing deformation caused by squeezing.

● Keep the rotor clean and dry to avoid tubing excessive wear and premature failure of pump head or drive.

● Please do not add the lubricating oil to the rotor by yourself, any improper operation could corrode the pump head housing or dislocate the tubing

● Please connect the power cord, control cable, communication cable in correct way, and do not damage the plug.

● If the pump head can't resist organic solvent and corrosive liquid, please clean the liquid left on the surface of the pump head in time.

1.2 Warranty and Service

1.2.1 Warranty Service

(1) Longer, obligation under this warranty is limited to a period of one (1) year from the date of original purchase. Within the 1 year of warranty period, Longer will replace or repair any defective parts free of charge. This warranty doesn't cover consumable part (tubing).

(2) Warranty does not cover:

● The repair or exchange of the entire unit after the warranty period.

● Any damage or failure caused by improper installation, storage, maintenance or usage, not in compliance with operating manual.

● Beyond or violate the conditions listed in contract or technical agreement.

● Any damage or failure caused by attempts by personnel other than authorized Longer representatives to install, repair, modify or remove the product.

● Any damage or failure caused by non-Longer parts, or user-replaceable parts purchased from unauthorized distributors.

- Any damage or failure caused by accidents or human errors (including wrong power supply voltage, corrosion, fall-off, etc.)
- Any damage or failure caused by natural disaster or other irresistible force (earthquake, fire, etc.).
- Other product damage or failure not caused by defects in design, material and workmanship.

1.2.2 Maintenance Service

- Customer will be charged for the repair or replacement of the parts or accessories after warranty period.
- Parts can be replaced within 3 working days. Longer will inform customer of the date in advance if out of 3 working days.

1.2.3 Service Commitment

- Longer commits to provide customer solutions to any quality complaint within 2 working days.
- Longer commits to reply to customer's requirement of on-site technical supports or training within 2 working days.

1.2.4 Dispute Settlement

Dispute over product quality or service will be handled according to contract or agreement. If there is no related contract or agreement, it shall be resolved by the disputing parties through consultation. Otherwise, it will be resolved according to relevant national laws and regulations.

1.3 Repair Notes

Please contact Longer or its distributor, and provide the product serial number before returning the product. Products which has been contaminated with, or exposed to, toxic chemicals or any other substance hazardous to health must be decontaminated before returning to Longer or its distributor. You must ship the product in its original packaging or better, to insure it against possible damage or loss during the transport.

1.4 Contacts Information

Longer Precision Pump Co., Ltd
3rd Floor, Building 6B, University Science Park Baoding National, High - Tech
Industrial Development Zone.
Baoding, Hebei, China 071051
Email: longer@longerpump.com
Tel: 86-312-3110087
Fax: 86-312-3168553
www.longerpump.com

2 Product Introduction

2.1 Main Features of G100-1J/ G300-1E/ G300-1J

G100-1J, G300-1E and G300-1J are industrial peristaltic pump drives especially designed for severe environment. The pumps have compact structure and small size, which are suitable for limited installation space. With good electromagnetic compatibility, the pump will not behave unacceptably in the EMI environment and will not interfere with other electronic equipment nearby. It also has high IP rating (IP65), which is suitable for wet and dusty environment. In addition, it has aluminum alloy housing with anti-corrosion paint treatment to improve the corrosion resistant performance. G100-1J, G300-1E and G300-1J are compatible with many Longer peristaltic pump heads and accepts many different tubings. The max flowrate of G100-1J is 500mL/min (single channel), the max flowrate of G300-1E is 1100 mL/min (single channel), and the max flowrate of G300-1J is 1500 mL/min (single channel).

2.2 Unpacking

To unpack the pump, follow below steps:

- 1) Take out the pump and the accessories from the shipping carton;
- 2) In case of any question, please contact Longer or the local distributor.

2.3 System Structure

G100-1J/ G300-1E/ G300-1J peristaltic pump includes the following parts:

- ① Peristaltic pump drive
- ② Pump head + tubing

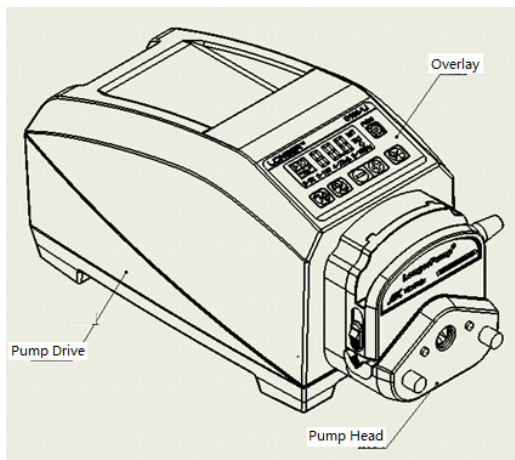

2.3.1 Peristaltic Pump Drive

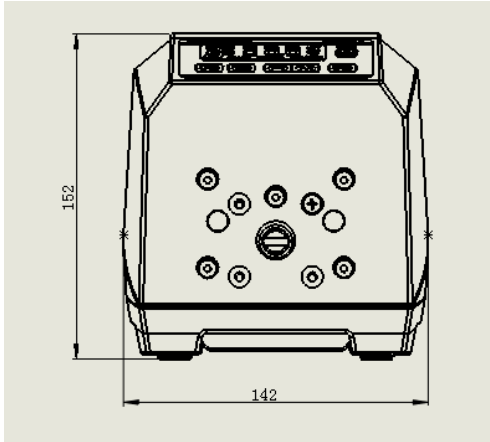

“Anchor gasket” is the default configuration of the drive, mainly used for buffer and vibration attenuation. When it is needed to fix the drive on an external platform, an “adapter bracket” should be selected. Please refer to chapter 3.1.2, “Fixing of G100-1J/G300-1E/G300-1J”, for removing the “anchor gasket” and mounting “adapter bracket”. Please refer to chapter 3.1.3, “Grounding of G100-1J/ G300-1E/ G300-1J”, for the use of the “grounding rod”.

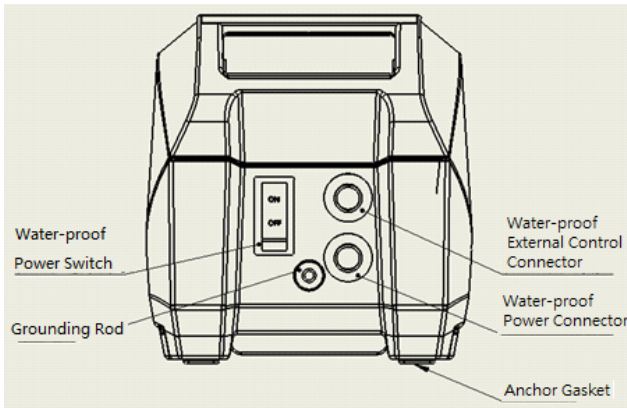

2.3.2 Applicable Pump Head and Tubing, and Reference Flow Rate

The pump head and tubing are used to transfer the fluid. Please refer to below table for the applicable pump heads and tubings.

Table 1 Applicable Pump Head and Tubing, and Reference Flow Rate of G100-1J

Pump Head	Applicable Silicone Tubing	Applicable Pharmed Tubing	Reference Flow Rate (silicone tubing) mL/min
YZ1515X、YZII 15	13#、14#、19#、16#、25#、17#、18#	13#、14#、19#、16#、25#、17#、18#	0-380
FG15-13	13#、14#、19#、16#、25#、17#、18#	13#、14#、19#、16#	0-430
DMD15-13-B DMD15-13-D	2*13#、2*14#、2*19#、2*16#、2*25#	2*13#、2*14#、2*19#、2*16#	0-375
BZ15-13-A	14#	14#	0-22
BZ15-13-B	16#	16#	0-80
BZ15-13-C	25#	25#	0-150
BZ15-13-D	17#	17#	0-270
DG15-24	16#、25#、17#	Not recommended	0-300 (Single Channel)
DG-1,DG-2,DG-4 6 rollers	ID≤3.17mm Wall thickness: 0.8-1mm	ID≤3.17mm Wall thickness: 0.8-1mm	0-48 (single channel)
DG-6, DG-8 6 rollers	ID≤3.17mm Wall thickness: 0.8-1mm	Not recommended	0-48 (single channel)
DG-1,DG-2 10 rollers	ID≤3.17mm Wall thickness: 0.8-1mm	ID≤3.17mm Wall thickness: 0.8-1mm	0-32 (single channel)
DG-4 10 rollers	ID≤3.17mm Wall thickness: 0.8-1mm	Not recommended	0-32 (single channel)
YZII 25	15#、24#、35#、36#	Not recommended	0-500
YZ2515X	15#、24#	Not recommended	0-270
FG25-13	15# 24#	Not recommended	0-320
BZ25-13-B	24#	Not recommended	0-250

Note: The flow rate in above table is only for the reference, which were tested at the indoor temperature with water. When select pump head and tubing, the decay of flow and the fluid viscosity need to be considered.

Table 2 Applicable Pump Head and Tubing, and Reference Flow Rate of G300-1E (only recommend silicone tubing).

Pump Head	Applicable Silicone Tubing	Reference Flow Rate mL/min
YZ1515X、YZII 15	13#、14#、19#、16#、 25#、17#、18#	0-1100
FG15-13	13#、14#、19#、16#、25#	0-690
DMD15-13-B DMD15-13-D	2*13#、2*14#、2*19#、 2*16#、2*25#	0-1035
BZ15-13-A	14#	0-75
BZ15-13-B	16#	0-230
BZ15-13-C	25#	0-480
BZ15-13-D	17#	0-800
DG15-24	16#、25#、17#	0-900 (Single Channel)
YZII 25	15#、24#、35#	0-1100
YZ2515X	15#、24#	0-800
BZ25-13-B	24#	0-800

Note: The flow rate in above table is only for the reference, which were tested at the indoor temperature with water. When select pump head and tubing, the decay of flow and the fluid viscosity need to be considered.

Table 3 Applicable Pump Head and Tubing, and Reference Flow Rate of G300-1J

Pump Head	Applicable Silicone Tubing	Applicable Pharmed Tubing	Reference Flow Rate (silicone tubing) mL/min
YZ1515X、YZII 15	13#、14#、19#、16#、25#、17#、18#	13#、14#、19#、16#、25#、17#、18#	0-1100
FG15-13	13#、14#、19#、16#、25#、17#、18#	13#、14#、19#、16#	0-1200
DMD15-13-B DMD15-13-D	2*13#、2*14#、2*19#、2*16#、2*25#	2*13#、2*14#、2*19#、2*16#	0-1035
BZ15-13-A	14#	14#	0-75
BZ15-13-B	16#	16#	0-230
BZ15-13-C	25#	25#	0-480
BZ15-13-D	17#	17#	0-800
DG15-24	16#、25#、17#	Not recommended	0-900 (Single Channel)
YZII 25	15#、24#、35#、36#	Not recommended	0-1500
YZ2515X	15#、24#	Not recommended	0-800
FG25-13	15#、24#	Not recommended	0-1100
BZ25-13-B	24#	Not recommended	0-800

Note: The flow rate in above table is only for the reference, which were tested at the indoor temperature with water. When select pump head and tubing, the decay of flow and the fluid viscosity need to be considered.

2.4 Function & Specification

2.4.1 Main Functions

- Applicable pump heads for G100-1J: YZ1515X, YZII15, FG15-13, BZ15, DMD15, DG15-24, YZ2515X, YZII25, FG25-13, BZ25, DG-1, DG-2, DG-4, DG-6 and DG-8.
- Applicable pump heads for G300-1E: YZ1515X, YZII15, FG15-13, BZ15, DMD15, DG15-24, YZ2515X, YZII25, BZ25.
- Applicable pump heads for G300-1J: YZ1515X, YZII15, FG15-13, BZ15, DMD15, DG15-24, YZ2515X, YZII25, BZ25, FG25-13.
- Control modes: Four control modes are available: keypad control mode, footswitch control mode, communication control mode, and external signal control mode (start and stop control, running direction control, and speed control)
- Running direction control: CW and CCW are available. The running direction could be controlled by keypad or external signal. When controlled by external signal, the trigger mode could be set as level (momentary) or pulse (maintained), the signal is switch signal (dry contact).
- Start and stop control: When start/ stop is controlled by footswitch or external signals, the trigger mode can be set as level (momentary) or pulse (maintained), the signal is switch signal (dry contact).
- Speed controlled by external signals: 4-20mA /0-5V /0-10V /0-10kHz signals are optional with uniform interface, and the max speed is settable between 10rpm and 100rpm for G100-1J, and between 30rpm and 300rpm for G300-1E/ G300-1J.
- Communication control: RS485 interface, compatible with both Longer protocol and Modbus RTU protocol, and the protocol could be identified automatically.
- Prime function: Fast filling or emptying at full speed.
- Display function: LCD displays all control information, pump state and set parameters
- Electromagnetic compatibility: Good electromagnetic compatibility, in conformity with the requirements of most industrial application.
- Keypad lock function: Keypad can be locked to prevent the misoperation. The delay time before lock is also settable.
- Memory function: The state and parameters will be saved automatically, and could be used directly when power on.
- Pump state when power up: The pump state when power up could be set as stop or as the state before power loss.

2.4.2 Specifications

3.1.2 Fixing of G100-1J/ G300-1E/ G300-1J

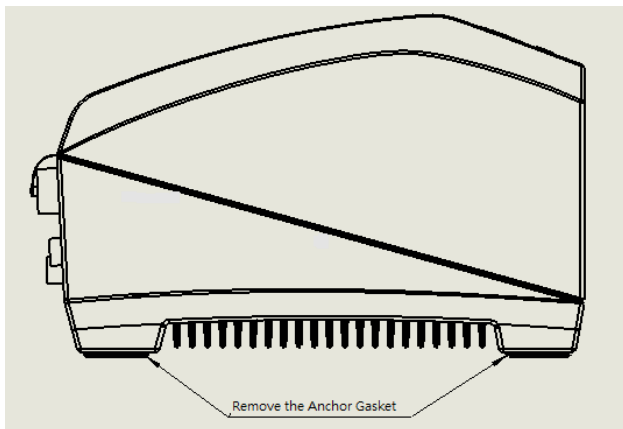

Remove Anchor Gasket by Hand

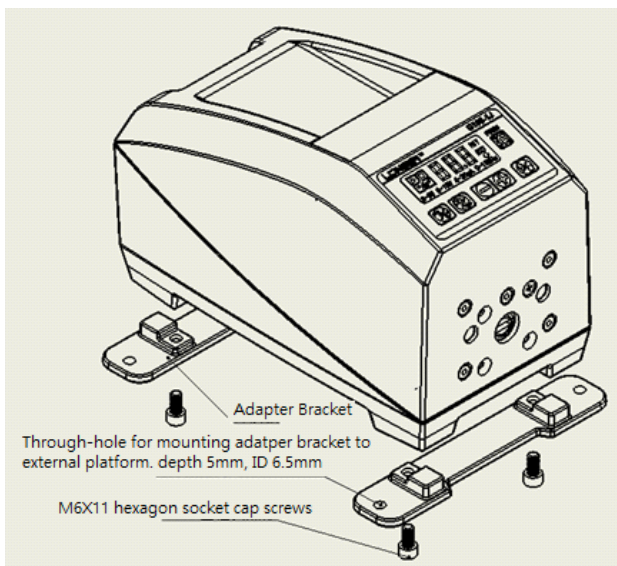

Fixing of Adapter Bracket (Optional)

3.1.3 Grounding of G100-1J/ G300-1E/ G300-1J

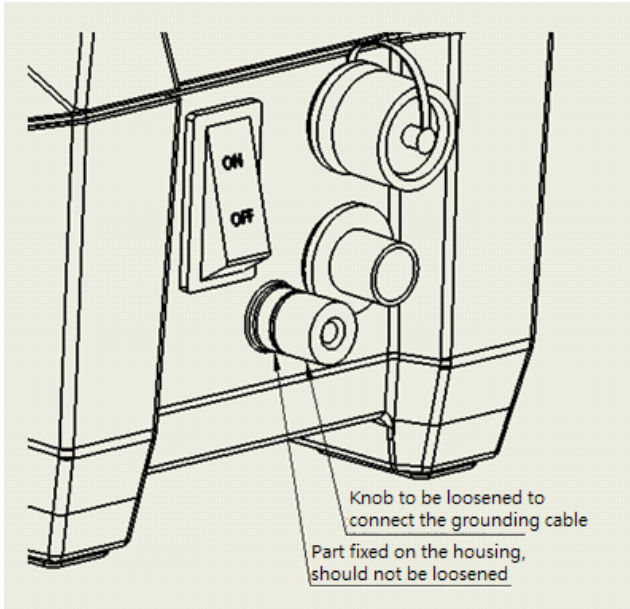

G100-1J, G300-1E and G300-1J are equipped with grounding rod. The pump could be grounded well through the grounding rod. Grounding the pump will prevent the misoperation and damage because of the electromagnetic interference.

Grounding steps:

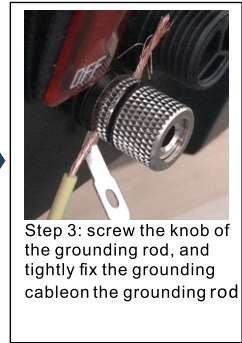
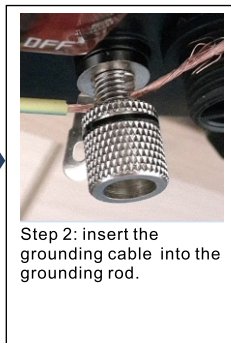
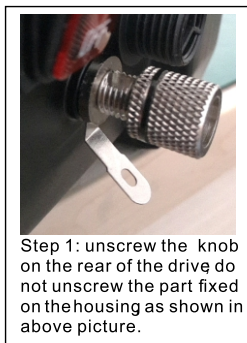

Or directly solder the grounding cable on the grounding rod.

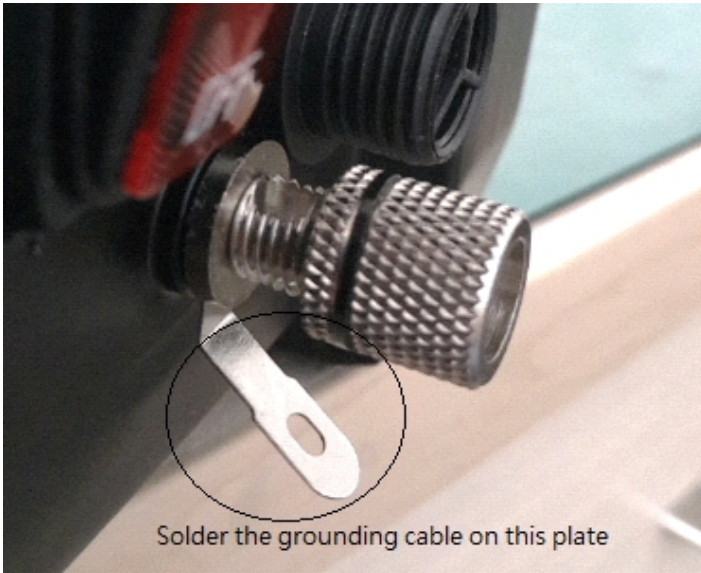

3.2 Installation of Pump Head

3.2.1 Installation of Pump Head

YZ1515x/YZ2515x/YZII15/YZII25

Insert the tang of the pump head shaft into the slot of the black rubber coupling, and insert the alignment pin of the drive unit into the alignment hole on the back of the pump head, then tighten the mounting screws.

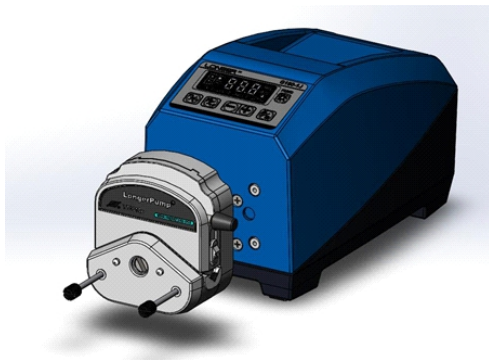

3.2.2 Installation of Pump Head FG15-13/FG25-13

Mounting the pump head:

Mount the mounting plate on the drive unit through tightening three mounting screws M4X10. Insert the tang of the pump head shaft into the slot of the black rubber coupling, turn the pump head 45 degree relative to the vertical direction, engage the bayonet on the mounting plate with the bayonet slot on the back of the pump head, turn the pump head clockwise until it locks into an upright position.

Remove the pump head:

Push the locking lever back and turn the pump head anti-clockwise about 45 degree. Then take off the pump head from the mounting plate.

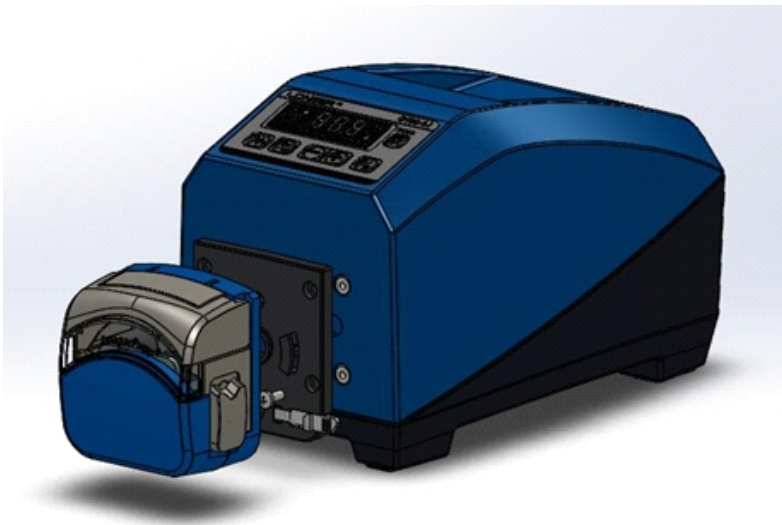

3.2.3 Installation of Pump Head DMD15-13 and Tubing

Pump Head Mounting:

Mount the mounting plate on the drive unit through three cross recess head screws M4X10. Release the two levers to open the pump head and remove the compression block. Insert the tang of the pump head shaft into the slot of the black rubber coupling. Press the pump head firmly against the mounting plate. Turn the pump head to align the mounting holes on the pump head with the mounting holes on the mounting plate. Insert the two mounting screws (hexagon socket head cap screw M3X8) into the mounting holes, then tighten them.

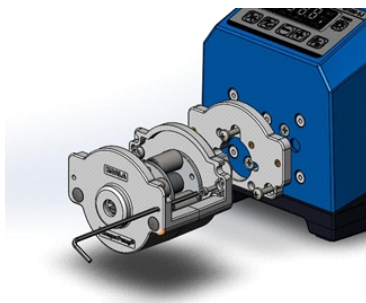
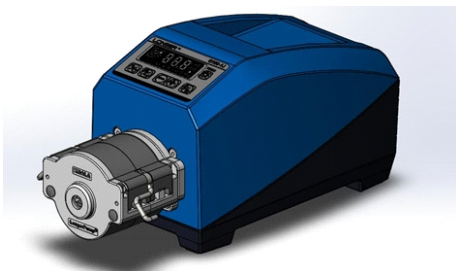

Tubing Loading:

Release the levers to remove the compression block. Insert the tubing fitting assembly into the compression block.

Note: When use 25# tubing, the partition block needs to be fixed at the outermost positioning hole.

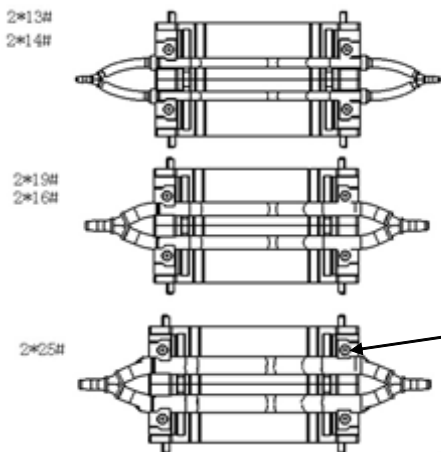

The four partition blocks need to be fixed at the outermost positioning holes

Put the compression block with tubing fitting assembly back to the pump head, and lock the levers.

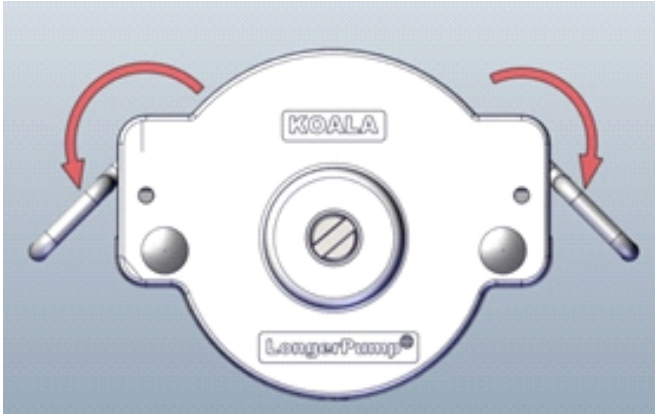

4 System Operation

4.1 Keypad and LCD

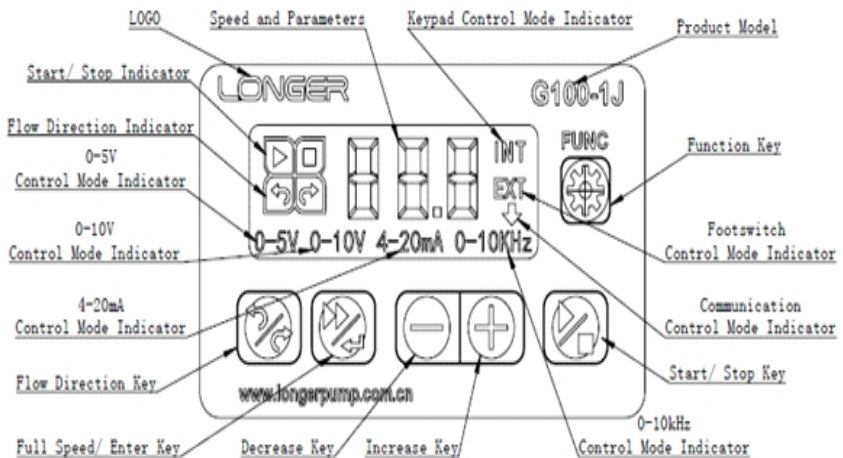

4.2 Basic Operation (Introduction about the keypads' functions)

4.3 Run Screen

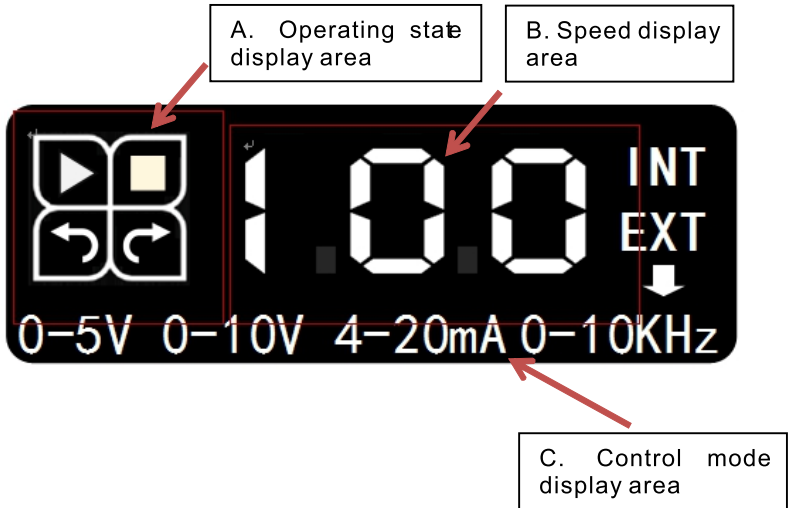

Run Screen Introduction:

a. The running state and the flow direction are displayed in the operating state.



“▶” and “◻” indicate the running and stop state of the pump respectively. When the pump is running, the indicator light ▶ will be on; when it stops, the indicator light ◻ will be on. “▶” and “◻” indicate the flow direction of the pump. When the pump is running clockwise, the indicator light ▶ will be on; when it is running anti-clockwise, the indicator light ◻ will be on.

b. The set speed is indicated in the speed display area. Speed range of G100-1J: 0-100(rpm), resolution is 0.1 rpm. Speed range of G300-1E/ G300-1J: 0-300(rpm), resolution is 1 rpm.

c. Seven different control modes will be displayed in the control mode display area. Only one mode will be displayed at a time. “INT” is for the keypad control mode, “EXT” is for the footswitch control mode, “◻” is for the communication control mode, “0-5V” is for the external signal control mode with speed signal of 0-5V, “0-10V” is for the external signal control mode with speed signal of 0-10V, “4-20mA” is for the external signal control mode with speed signal of 4-20mA, and “0-10KHz” is for the external signal control mode with speed signal of 0-10KHz.

4.4 Control Mode Introduction and Mode Switch





Control mode: The pump could run in seven control modes: keypad control mode, screen displays symbol “INT”; footswitch control mode, screen displays symbol “EXT”; communication control mode, screen displays symbol“”; external signal control mode with 0-5V speed signal, screen displays symbol “0-5V”; external signal control mode with 0-10V speed signal, screen displays symbol “0-10V”; external signal control mode with 4-20mA speed signal, screen displays symbol “4-20mA”; external signal control mode with 0-10KHz speed signal, screen displays symbol “0-10KHz”. The control mode can switch over by tap the Function Key .

1 The keypad control mode [INT]: If the pump is going to be controlled through the keypad, the control mode needs to be set as “INT” firstly. Then the start/ stop state, running direction and speed adjustment of the pump can be directly controlled through the keypad.

In the keypad control mode, press and hold the Function Key  to enter the parameter setting screen. Following parameters can be set: pump state when power up (stop or as the state before power loss), keypad lock and delay time before lock.

2 The footswitch control mode [EXT]: If the start/ stop of the pump is going to be controlled by a footswitch, dispensing controller or other devices, the control model needs to be set as “EXT” firstly. Connect the external start/ stop control signal to Pin 1 and Pin 8 of the external control port, and start and stop the pump through different signals (refer to Chapter 4.5.3 for signal type and control logic). In this control mode, both the running direction and the speed adjustment need to be controlled by the keypads. The trigger mode of external start/ stop control can be set as the level mode (momentary) or the pulse mode (maintained), and the type of control signal is switch signal (dry contact).

In the footswitch control mode, press and hold the Function Key  to enter the parameter setting screen. Following parameters can be set: start/ stop control trigger mode.

3 Communication control mode []: If the pump is going to be controlled by external computer or microprocessor through communication interface RS485, the control mode needs to be set as “” firstly. Connect the A and B of the RS485 bus to the Pin 6 and Pin 7 of the external control port. The pump is compatible with Longer OEM protocol and Modbus (RTU) protocol, and capable

of automatic protocol identification. In the communication control mode, the computer can control the start/ stop, running direction and the speed of the pump by sending the commands to pump. In the communication control mode, keypad control, footswitch control and external signal control are invalid. In the communication control mode, press and hold the Function Key  to enter the parameter setting screen. Following parameters can be set: pump address, baud rate, parity and stop bit.

4 External signal control mode with 0-5V speed control signal [0-5V]: If the pump is going to be controlled by external signals and the speed control signal is 0-5V, the control mode needs to be set as “0-5V” firstly. The start/ stop control signal shall be connected to Pin 1 (Pin 8 is COM), the running direction control signal to Pin 2 (Pin 8 is COM), and the speed control signal (0-5V) to Pin 3 (Pin 8 is COM). Please refer to Chapter 4.6.1 “Definition of External Control Port”. Both the start/stop signal and the direction control signal are switch signals (dry contacts). The trigger mode can be set as level (momentary) or pulse (maintained). In the external control mode, the max speed corresponding to the maximum speed control signal can be set. For example, the pump speed corresponding to the speed control signal 0-5V can be set as 0-50rpm. Speed is in linear correlation with signal.

In “0-5V” control mode, press and hold the Function Key  to enter the parameter setting screen. Following parameters can be set: the maximum speed corresponding to 5V signal, and the running direction control trigger mode.

Notes:

- 1 In the external signal control mode, keypad control and communication control are invalid.
- 2 The start/ stop control trigger mode needs to be set in the setting screen of the “footswitch

5 External signal control mode with 0-10V speed control signal [0-10V]: If the pump is going to be controlled by external signals and the speed control signal is 0-10V, the control mode needs to be set as “0-10V” firstly. The start/ stop control signal shall be connected to Pin 1 (Pin 8 is COM), the running direction control signal to Pin 2 (Pin 8 is COM), and the speed control signal (0-10V) to Pin 3 (Pin 8 is COM). Please refer to Chapter 4.6.1 “Definition of External Control Port”. Both the start/stop signal and the direction control signal are switch signals (dry contacts). The trigger mode can be set as level (momentary) or pulse (maintained). In the external control mode, the max speed corresponding to the maximum speed control signal can be set. For example, the pump speed corresponding to the speed control signal 0-10V can be set as 0-50rpm. Speed is in linear correlation with signal.

In “0-10V” control mode, press and hold the Function Key  to enter the parameter setting screen. Following parameters can be set: the maximum speed corresponding to 10V signal, and the running direction control trigger mode.

Notes:

1 In the external signal control mode, keypad control and communication control are invalid.

2 The start/ stop control trigger mode needs to be set in the setting screen of the “footswitch control mode”.

6 External signal control mode with 4-20mA speed control signal [4-20mA]:

If the pump is going to be remote controlled by external signals and the speed control signal is 4-20mA, the control mode needs to be set as “4-20mA” firstly. The start/ stop control signal shall be connected to Pin 1 (Pin 8 is COM), the running direction control signal to Pin 2 (Pin 8 is COM), and the speed control signal (4-20mA) to Pin 4 (Pin 5 is COM). Please refer to Chapter 4.6.1 “Definition of External Control Port”. Both the start/stop signal and the direction control signal are switch signals (dry contacts). The trigger mode can be set as level (momentary) or pulse (maintained). In the external control mode, the max speed corresponding to the maximum speed control signal can be set. For example, the pump speed corresponding to the speed control signal 4-20mA can be set as 0-50rpm. Speed is in linear correlation with signal.

In “4-20mA” control mode, press and hold the Function Key  to enter the parameter setting screen. Following parameters can be set: the maximum speed corresponding to 20mA signal, and the running direction control trigger mode.

Notes:

1 In the external signal control mode, keypad control and communication control are invalid.

2 The start/ stop control trigger mode needs to be set in the setting screen of the “footswitch control mode”.

7 External signal control mode with 0-10KHz speed control signal [0-10KHz]:

If the pump is going to be remote controlled by external signals and the speed control signal is 0-10KHz, the control mode needs to be set as “0-10KHz” firstly. The start/ stop control signal shall be connected to Pin 1 (Pin 8 is COM), the running direction control signal to Pin 2 (Pin 8 is COM), and the speed control signal (0-10KHz) to Pin 3 (Pin 8 is COM). Please refer to Chapter 4.6.1 “Definition of External Control Port”. Both the start/stop signal and the direction control signal are switch signals (dry contacts). The trigger mode can be set as level (momentary) or pulse (maintained). In the external control mode, the max speed corresponding to the maximum speed control signal can be set. For example, the pump speed corresponding to the speed control signal 0-10KHz can be set as 0-50rpm. Speed is in linear correlation with signal.

In “0-10KHz” control mode, press and hold the Function Key  to enter the parameter setting screen. Following parameters can be set: the maximum speed corresponding to 10kHz signal, and the running direction control trigger mode.

Notes:

1 In the external signal control mode, keypad control and communication control are invalid.

2 The start/ stop control trigger mode needs to be set in the setting screen of the “footswitch control mode”.

4.5 Parameter Settings

Parameter Settings

No.	Parameters	Setting Method	Setting Value
1	Pump state when power up	In the "INT" mode, press and hold the key to enter the parameter setting screen, tap the key "+" / "-" to set the parameters; tap the key to confirm the parameter setting and switch to the next parameter.	"": the pump will stop when power resumes; "": the pump will be the state before power loss when power resumes.
2	Keypad lock		"OFF": the keypad will not lock; "0.1min-10min": the keypad will lock automatically and the delay time before lock is **min, and resolution of the time is 0.1min.
3	Trigger mode of footswitch control and external start/ stop control	In the "EXT" mode, press and hold the key to enter the parameter setting screen, and tap the key "+" / "-" to set the trigger mode.	"000": level trigger mode (momentary); "111": pulse trigger mode (maintained).
4	Pump address	In the mode, press and hold the key to enter the parameter setting screen, and tap the key "+" / "-" to set the parameters; tap the key to confirm the parameter setting and switch to the next parameter.	A01-A32: corresponding to address 1-32.
5	Communication baud rate		12:1,200bps; 24:2,400bps; 48:4,800bps; 96:9,600bps; 192:19.2Kbps; 384:38.4Kbps
6	Communication parity		P-N: no parity; P-O: odd parity; P-E: even parity;
7	Communication stop bit		S-1: 1 stop bit; S-2: 2 stop bits.
8	Max speed of external signal control	In the "0-5V" / "0-10V" / "4-20mA" / "0-10KHz" mode, press and hold the key to enter the parameter setting screen, and tap the key "+" / "-" to set the parameters. press the key to switch to the next parameter.	G100-1J: 10.0rpm-100rpm, resolution of adjustment is 0.1rpm G300-1E/ G300-1J: 30rpm-300rpm, resolution of adjustment is 1rpm
9	Trigger mode of External running direction control		"000": level trigger mode (momentary); "111": pulse trigger mode (maintained).

Note:

The new setting parameters will not be valid until LCD returns to Run Screen.

4.5.1 Pump State When Power Up

The pump state when power up could be set as stop or as the state before power loss.

Setting steps:

1 When the pump stops, tap the Function Key to set the control mode as the keypad control mode "INT".

2 Press and hold the Function Key to enter the parameter setting screen, then the LCD displays the current setting of pump state when power up.





pump will be the state before power loss when power resumes



pump will stop when power resumes

3 Tap the key “+”/ “-”  to change the power state when power up.

4 Tap the Full Speed/ Enter Key  to confirm the settings of pump state when power up and enter the keypad lock setting screen. Tap the Full Speed/ Enter Key  again to save the parameter settings and return to the Run Screen.

4.5.2 Automatic Keypad Lock



The keypad lock function can be used to lock the keypad when the keypad is idle. Moreover, the delay time between the beginning idle and locking can be set, so as to prevent any misoperation.

The setting range of delay time between the beginning idle and locking: 0.1min-10min.

Setting steps:

1 When the pump stops, tap the Function Key  to set the control mode as the keypad control mode “INT”.

2 Press and hold the Function Key  to enter the parameter setting screen, then the LCD displays the current setting of pump state when power up.

3 Tap the Full Speed/ Enter Key  or press and hold the Function Key  to enter the parameter setting screen of automatic keypad lock, then the LCD displays the current setting of keypad lock (The factory default setting is not to lock automatically, and the LCD displays “OFF”).



Not lock automatically



Delay time between the beginning idle and locking is 10min

4 Tap the key “+”/ “-”  to set the automatic lock function and the lock delay time.

5 Tap the Full Speed/ Enter Key  to save the settings and return to the Run Screen.

Note:

When the keypad is automatically locked, it can be unlocked by pressing and holding the Function Key .

4.5.3 Trigger Model of External Start/ Stop Control

The start/ stop of the pump could be controlled by a footswitch, dispensing controller or PLC. If it only needs to control start/stop of the pump remotely by external signal, the pump could be set as the footswitch control mode “EXT”.

If it needs to control start/stop, running direction and speed of the pump remotely by external signals, the pump shall be set as the external signal control mode “0-5V”, “0-10V”, “4-20mA” or “0-10KHz”.

The trigger mode of external start/stop control can be set as level mode (momentary) or pulse (maintained). Control signal is switch signal (dry contact). Please refer to the following table for the type of signal, trigger mode and control logic.

The type of external start/ stop control signal	Trigger mode of start/ stop control	Control logic	Remarks
Switch signal	Level trigger (momentary)	When switch is open, the pump will run (the pump energized for the first time will be subject to a status change from closed to open). When switch is closed, the pump will stop (the pump energized for the first time will be subject to a status change from open to closed).	Pin 1 and Pin 8 of the external control port shall be connected to the two leads of the switch respectively.
	Pulse trigger (maintained)	When status change between open and closed of the switch occurs twice (closed->open->closed or open -> closed -> open), pump start/stop state will change once.	

Setting steps:

1 When the pump stops, tap the Function Key  to set the control mode as the footswitch control mode “EXT”;

2 Press and hold the Function Key  to enter the parameter setting screen, then the LCD displays the current setting of start/ stop trigger mode;



Level trigger mode



Pulse trigger mode

3 Tap the key “+”/ “-”  to set the trigger mode of external start/ stop control.

4 Tap the Full Speed/ Enter Key  to save the settings and return to the Run Screen.

4.5.4 Communication Parameters through Keypad

G100-1J/ G300-1E/ G300-1J could be controlled remotely by computer through serial communication with RS485 interface. And the pump is compatible with both Longer protocol and Modbus RTU protocol, which could be identified automatically. Before communication, the communication parameters can be set through keypad, including pump address, baud rate, parity and stop bit.

Setting range of each parameter:

Pump address: 1-32 (Modbus RTU protocol), 1-30 (Longer OEM protocol)

Baud rate: 12 (1,200bps), 24 (2,400bps), 48 (4,800bps), 96 (9,600bps), 192 (19,200bps) and 384 (38,400bps)

Parity: P-N (no parity), P-O (odd parity) and P-E (even parity)

Stop bit: S-1 (1 stop bit) and S-2 (2 stop bits)

Setting Steps:

1 When the pump stops, tap the Function Key  to set the control mode as the communication control mode “”.

2 Press and hold the Function Key  to enter the parameter setting screen, then the LCD displays the current pump address.



Pump address is 1



Pump address is 32

3 Tap the key “+”/ “-”  to set the pump address, setting range: 1-32 (Modbus RTU protocol), 1-30 (Longer communication protocol).

4 Tap the Full Speed/ Enter Key  to confirm the pump address and enter the

baud rate setting screen. Then the LCD displays the current setting of communication baud rate.



Baud rate: 1,200bps



Baud rate: 38,400bps

5 Tap the key “+”/ “-”  to set the communication baud rate. There are 6 options: 12 (1,200bps), 24 (2,400bps), 48 (4,800bps), 96 (9,600bps), 192 (19,200bps) and 384 (38,400bps);

6 Tap the Full Speed/ Enter Key  to confirm the communication baud rate, and enter the parity setting screen. Then the LCD displays the current setting of communication parity.



No parity



Odd parity



Even parity

7 Tap the key “+”/ “-”  to set the communication parity of the pump. There are 3 options: P-N (no parity), P-O (odd parity), and P-E (even parity);

8 Tap the Full Speed/ Enter Key  to confirm the communication parity and enter the stop bit setting screen. Then the LCD displays the current setting of communication stop bit.



1 stop bit



2 stop bits

9 Tap the key “+”/ “-”  to set the communication stop bit of the pump. There are 2 options: S-1 (1 stop bit) and S-2 (2 stop bits);

10 Tap the Full Speed/ Enter Key  to save the communication parameters, and return to the Run Screen.

4.5.5 Max Speed of External Signal Control

When the pump is set as the external signal control mode, the speed can be controlled by the speed control signals (0-5V, 0-10V, 4-20mA or 0-10KHz) from the PLC and other controllers. The max speed could be set according to actual application. For G100-1J, the default value of max speed is 100rpm, and the setting range of the max speed is 10rpm-100rpm. For G300-1E/ G300-1J, the default value of max speed is 300rpm, and the setting range of the max speed is 30rpm-300rpm. For example, when the speed control signal is 0-5V, and the max speed is set as 50rpm. Then, the speed range corresponding to 0-5V signal is 0-50rpm, and the speed is in linear correlation with the signal.

Setting steps:

1 When the pump stops, tap the Function Key  to set the control mode as the external signal control mode “0-5V”, “0-10V”, “4-20mA” or “0-10KHz” (based on the actual speed control signals);

2 Press and hold the Function Key  to enter the parameter setting screen, then the LCD displays the current setting of max speed corresponding to the max signal.



G100-1J Max speed: 100rpm



G100-1J Max speed: 23.5rpm





G300-1E/ G300-1J Max speed: 300rpm



G300-1E/ G300-1J Max speed: 30rpm

3 Tap the key "+" / "-"  to set the max speed of external signal control, setting range of G100-1J is 10rpm-100rpm; setting range of G300-1E/ G300-1J is 30rpm-300rpm.

4 Tap the Full Speed/ Enter Key  to confirm the max speed of external signal control and enter the setting screen for trigger mode of external running direction control.

Tap the Full Speed/ Enter Key  again to save the settings, and return to the Run Screen.

4.5.6 Trigger Mode of External Running

Direction Control

When the pump is set as the external signal control mode "0-5V", "0-10V", "4-20mA" or "0-10KHz", the pump running direction (CW or CCW) could be controlled remotely by PLC or other controllers.



The trigger mode of external running direction control can be set as level mode (momentary) or pulse (maintained). Control signal is switch signal (dry contact). Please refer to the following table for the type of signal, trigger mode and control logic.

The type of running direction control signal	Trigger mode of running direction control	Control logic	Remarks
Switch signal	Level trigger (momentary)	When switch is open, the pump will run clockwise (the pump energized for the first time will be subject to a status change from closed to open). When switch is closed, the pump will run counter-clockwise (the pump energized for the first time will be subject to a status change from open to closed).	Pin 2 and Pin 8 of the external control port shall be connected to the two leads of the switch respectively.
	Pulse trigger (maintained)	When status change between open and closed of the switch occurs twice (closed->open->closed or open -> closed -> open), running direction will change once.	

Setting Steps:

1 When the pump stops, tap the Function Key  to set the control mode as the external signal control mode "0-5V", "0-10V", "4-20mA" or "0-10KHz" (based on the actual speed control signals);

2 Press and hold the Function Key  to enter the parameter setting screen, then the LCD displays the current setting of max speed corresponding to the max speed signal.



3 Tap the Full Speed/ Enter Key  or press and hold the Function Key  to enter the setting screen for trigger mode of external running direction control. Then the LCD displays the current setting of the trigger mode;



Level trigger mode



Pulse trigger mode

- 4 Tap the key “+”/ “-”  to set the trigger mode of external running direction control.
- 5 Tap the Full Speed/ Enter Key  to save the settings, and return to the Run Screen.

4.6 External Signal Control

4.6.1 Definition of External Control Port

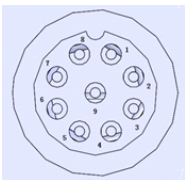

External control port

Pin 1: External start/stop control input. The trigger mode of external start/stop control can be set as level mode (momentary) or pulse mode (maintained). Control signal is switch signal (dry contact). Please refer to Chapter 4.5.3 for the trigger mode and control logic.

Pin 2: External running direction control input. The trigger mode of external running direction control can be set as level mode (momentary) or pulse mode (maintained). Control signal is switch signal (dry contact). Please refer to Chapter 4.5.6 for the trigger mode and control logic.

Pin 3: External speed control signal (0-5V, 0-10V or 0-10KHz) input. Connected to 0-5V, 0-10V or 0-10KHz signal +. The speed is in linear correlation with signal.

Pin 4: External speed control signal (4-20mA) input. Connected to 4-20mA signal +. The speed is in linear correlation with signal.

Pin 5: COM for the external speed control signal (4-20mA). Connected to 4-20mA signal -.

Pin 6: A of serial communication RS485. In the communication control mode, this pin is connected to the A of RS485.

Pin 7: B of serial communication RS485. In the communication control mode, this pin is connected to B of RS485.

Pin 8: COM for start/stop signal, running direction signal, 0-5V/0-10V/0-10KHz speed signal, and ground of RS485.

Pin 9: Connected to the shielded wire of external signal control cable. It is recommended that the external signal control cable has shielded wire, which should be connected to Pin 9.

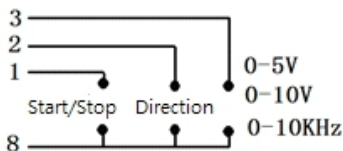

Wiring Diagram A of External Control Port
(0-5V/0-10V/0-10KHz External Signal Control Mode)

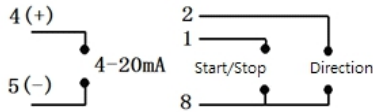

Wiring Diagram B of External Control Port
(4-20mA External Signal Control Mode)

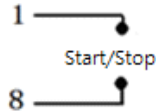

Wiring Diagram C of External Control Port
(Footswitch Control Mode)

4.6.2 Operating Steps for External Signal Control

Operating steps for external signal control:

- 1 Set the trigger mode of external start/ stop control according to Chapter 4.5.3;
- 2 Set the max speed of external signal control according to Chapter 4.5.5. If the max speed needed is the default value of 100rpm for G100-1J, or 300rpm for G300-1E/ G300-1J, this step is unnecessary;
- 3 Set the trigger mode of external running direction control according to Chapter 4.5.6;
- 4 Power off the pump, and connect the external signal control cable according to Chapter 4.6.1;
- 5 Power on the pump, and control the pump through external control signals.

4.7 Footswitch Control

When the pump is set as the footswitch control mode “EXT”, start/ stop of the pump can be controlled by a footswitch, dispensing controller or other devices.

Operating steps for footswitch control:

- 1 When the pump stops, tap the Function Key  to set the control mode as the footswitch control mode “EXT”.
- 2 Set the trigger mode of external start/ stop control according to Chapter 4.5.3.
- 3 Power off the pump, and connect the footswitch control signal to the Pin 1 and Pin 8 of the external control port.
- 4 Power on the pump, and set the speed and running direction through keypad.
- 5 Start and stop of the pump through the footswitch.

4.8 Communication Control

G100-1J, G300-1E and G300-1J could be controlled remotely (start/stop control, running direction control and speed control) by computer through serial communication with RS485 interface. And the pump is compatible with both Longer protocol and Modbus RTU protocol, which could be identified automatically.

4.8.1 Communication Control Using Longer OEM Protocol

Using the Longer OEM protocol, the pump address could be set as 1-30. Please refer to Appendix 1 for the protocol detail. The pump control mode needs to be set as communication control"  and the communication parameters need to be set through the keypad (refer to Chapter 4.5.4 for parameter setting). When the parameters setting is finished and return to the Run Screen to save the parameters, the pump is ready for the communication control. In the communication control mode, "pump state when power up" and "automatic keypad lock" still can be set through keypad. Please refer to Chapter 4.5.1 and Chapter 4.5.2 for details.

4.8.2 Communication Control Using Modbus

RTU Protocol

Using the Modbus RTU protocol, the pump address could be set as 1-32. Please refer to Appendix 2 for the register map. The pump control mode needs to be set as communication control"  ,The communication parameters setting for the first time needs to be done through keypad (refer to Chapter 4.5.4 for the details). The new communication parameters could also be set through communication commands if the current communication parameters are known. When the parameters setting is finished and return to the Run Screen to save the parameters, the pump is ready for the communication control. In the communication control mode, "pump state when power up" and "automatic keypad lock" can be set through either keypad (refer to Chapter 4.5.1 and Chapter 4.5.2 for details), or commands.

Appendix 1 Longer OEM Protocol

1 Frame format: 1start + 8data + 1even parity + 1stop, Baud rate could be 1,200bps, 2,400bps, 4,800bps, 9,600bps, 19,200bps and 38,400bps, which should be consistent with the baud rate setting through the keypad.

2 Message format: flag+ addr + len + pdu + fcs.

flag: E9H, the message head. When sending the message, the data E8H after message head will be replaced with E8H 00H, and E9H after message head will be replaced with E8H 01H. When receiving the message, the data E8H 00H after message head will be reverted to E8H, and E8H 01H after message head will be reverted to E9H. (Note: if E8 00 replaced E8 or E8 01 replaced E9, E8 00 or E8 01 will be regarded as one byte, no influence on the length of pdu.)

addr: one byte, pump address, 1-30. 31 is broadcast address.

len: one byte, length of pdu.

fcs: one byte, XOR of **addr**, **len** , **pdu**.

3 pdu format: application layer code format

3.1 PC sets pump's running parameter

PC sends command:

WJ	Speed (2bytes)	Full speed and start/stop (1 byte)	Direction (1 byte)
----	----------------	------------------------------------	--------------------

Pump responds:

WJ

- WJ: 2 bytes, using ASCII code, to indicate that this command is used to set pump's running parameter. ASCII code of W is 57H, ASCII code of J is 4AH.
 - Speed: 2 bytes, hexadecimal number, most significant byte first. The resolution of G100-1J is 0.1rpm, example: 0258H means 60rpm. The resolution of G300-1E/ G300-1J is 1rpm, example: 003CH means 60rpm.
 - Full speed and start/stop:
 - Bit0: 1 means pump runs, 0 means pump stops.
 - Bit1: 1 means full speed, 0 means normal speed.
 - Direction:
 - Bit0: 1 means CW, 0 means CCW.
- Note: When set the running parameter, the addr in message can be pump address (1-30) or broadcast address. All pumps will operate according to the same command without response when using broadcast address.

3.2 PC reads pump's running state

PC calls:

RJ

Pump responds:

RJ Speed (2bytes) Full speed and start/stop (1 byte) Direction (1 byte)

- RJ: 2 bytes, using ASCII code, to indicate that this call is used to read pump's running state. ASCII code of R is 52H, ASCII code of J is 4AH.

- Refer to para. 3.1 for instructions of speed, full speed, start/stop, direction

Note: When read the running state, the addr in the message only can be pump address (1-30).

3.3 PC sets pump address

PC sends command:

WID New pump address (1 byte)

Pump responds:

WID

WID: 3 bytes, using ASCII code, to indicate that this command is to set the pump address. ASCII code of W is 57H, ASCII code of I is 49H, ASCII code of D is 44H.

Note: When read the running state, the addr in the message could be pump address (1-30), and also could be the broadcast address 31. When using the broadcast address 31, there should be only one pump, which needs to be set with new address, in the communication bus, and there is no response from the pump.

3.4 Read pump address

PC calls:

RID

Pump responds:

RID

● RID: 3 bytes, using ASCII code, to indicate that this call is used to read pump address. ASCII code of R is 52H, ASCII code of I is 49H, and ASCII code of D is 44H.
 Note: When read the pump address, the addr in the message only can be pump address (1-30).

4 Example:

To set a G100-1J (addr: 01) to run CW at speed of 50rpm. The message should be:

E9 01 06 57 4A 01 F4 01 01 EF

To set a G300-1E/ G300-1J (addr: 01) to run CW at speed of 300rpm. The message should be:

E9 01 06 57 4A 01 2C 01 01 37

Appendix 2 Modbus RTU Protocol

Parameter	Address	Data Type	Note
Speed	0x01	uint_16	Range of G100-1J: 0-1,000 (corresponding to 0rpm-100rpm) Range of G300-1E/ G300-1J: 0-300 (corresponding to 0rpm-300rpm)
Pump state	0x02	uint_16	Low order byte is valid. BIT0:1 for run, and 0 for stop; BIT1:1 for full speed, and 0 for normal speed; BIT4:1 for clockwise, and 0 for counter-clockwise; 0 for other bits.
Pump state when power up	0x03	uint_16	Low order byte is valid. 0XAA: when power up, pump will be the state before power loss, 0XFF: when power up, pump will stop.
Keypad lock time	0x04	uint_16	Low order byte is valid. Range: 0-100; unit: 0.1minute; 0: the keypad will not lock; other values XXX: the keypad will lock after the time of (XXX * 0.1) minutes.
Pump address	0x08	uint_16	Low order byte is valid. Range: 1-32; When the new pump address setting is finished, the pump address in command from computer needs to be set as the new address.
Communication baud rate	0x09	uint_16	Low order byte is valid. Range: 0-5, 0:1200bps; 1:2400bps; 2:4800bps; 3:9600bps; 4:19200bps; 5:38400bps. When baud rate setting is finished through the command, the new baud rate will be valid immediately. Then the baud rate in commands from computer needs to be set as the new baud rate.
Communication parity	0x0A	uint_16	Low order byte is valid. Range: 0-2, 0:NONE; 1:ODD; 2:EVEN When parity setting is finished through the command, the new parity will not be valid until power resumes or the pump receives the baud rate setting command. Then the parity in commands from computer needs to be set as the new parity.
Communication stop bit	0x0B	uint_16	Low order byte is valid. Range: 1-2, 1:1 stop bit; 2:2 stop bits When stop bit setting is finished through the command, the new stop bit will not be valid until power resumes or the pump receives the baud rate setting command. Then the stop bit in commands from computer needs to be set as the new stop bit.

Appendix 3 Alarm

In case of an operating error of the peristaltic pump, the error code will be displayed on the LCD, shown as follows:

Error code	Description	Remarks
E01	Parameters reading error when power up	Press and hold the Function Key to clear the alarm, then contact Longer to solve the problem.
E02	Connection error between the input circuit board of external signal control and the mainboard.	Press and hold the Function Key to clear the alarm, then contact Longer to solve the problem.

LONGER

Baoding Longer Precision Pump Co., Ltd.

Add: 3rd/4th Floor, Building 6B, University Science Park
Baoding National, High - Tech Industrial Development Zone
Baoding, Hebei, China 071051
Tel: 86 - 312 - 3110087 3138553
Fax: 86 - 312 - 3168553
E - mail: longer@longerpump.com
[Http://www.longerpump.com](http://www.longerpump.com)