

LONGER

BT300-1F PERISTALTIC PUMP OPERATING MANUAL

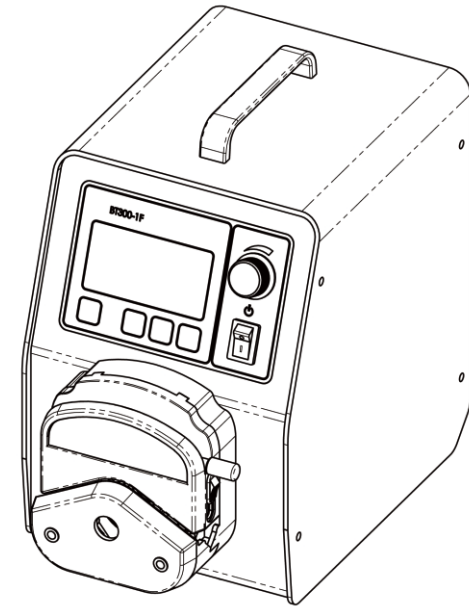

LONGER

Baoding Longer Precision Pump Co., Ltd.

Add: 3rd/4th Floor, Building 6B, University Science Park
Baoding National, High - Tech Industrial Development Zone
Baoding, Hebei, China 071051
Tel: 86 - 312 - 3110087 3138553
Fax: 86 - 312 - 3168553
E - mail: longer@longerpump.com
[Http://www.longerpump.com](http://www.longerpump.com)

November 2019

BT300-1F Longer Peristaltic Pump

Baoding Longer Precision Pump Co.,Ltd.

 **IMPORTANT INFORMATION :**

Please read operation manual carefully before operation.

 **WARNINGS :**

- Tubing breakage may result in fluid being sprayed from pump. Use appropriate measures to protect operator and equipment. Please check the tubing frequently and change the tubing in time.
- If the power line or the plug is worn or damaged please pull out the plug (Hold the plug not the power line when pulling out).
- Please shut down the power supply and pull out the plug when meet below circumstances (Hold the plug not the power line when pulling out).
The fluids splash on the body of the pump.
You think the pump needs to be maintained or repaired.
- Please shut down the power supply before install the external control equipments.

Table of Contents

Introduction	1
Operation Panel	2
Basic Operation	2
Start/Stop Key	2
Direction Key	2
Adjusting Knob	2
Prime Key	2
Exit Key	2
Running Interface	3
Menu Frame Work	4
Function Setting	4
Filling and Dispensing Setting	5
Calibration Function	7
System Setting	8
Tubing I.D.	9
Remote Control	10
Pump I.D.	10
Footswitch	11
Back Suction	11
Time Setting	12
Pump Head Selection	12
Control Mode	13
Acceptable Pump Heads and Tubing	14
Pump Head Mounting	15
Remote Control	15
Optional Accessories	18
Communication Function	18
Maintenance	18
Warranty	18
Technical Specifications	19

Introduction

BT300-1F peristaltic pump is a multi-function peristaltic pump developed by our company. It can connect many pump heads. The flow rates are 0.005 - 1140 mL/min. 128 x 64 graphic LCD displays running menus and parameter setting menus. The display interfaces are friendly. It has many control modes. The external control can be realized through standard external interface or 485 communication interface.

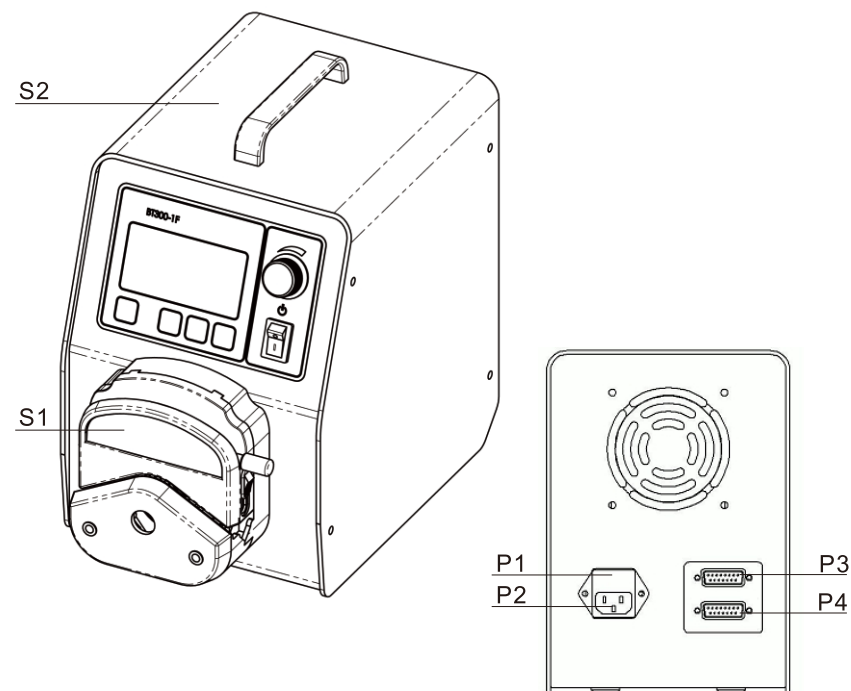

- | | |
|-----------------------------|------------------------------------|
| S Standard Configuration | P Parts |
| S1 Pump Head | P1 Build-in fuse |
| S2 Drive | P2 Power Socket |
| | P3 Remote Control Output Interface |
| | P4 Remotel Control Input Interface |
| OP Optional Fittings | |
| OP1 External Control Module | |

Reference:

For detail information about remote control function please see page 15.

Operation Panel

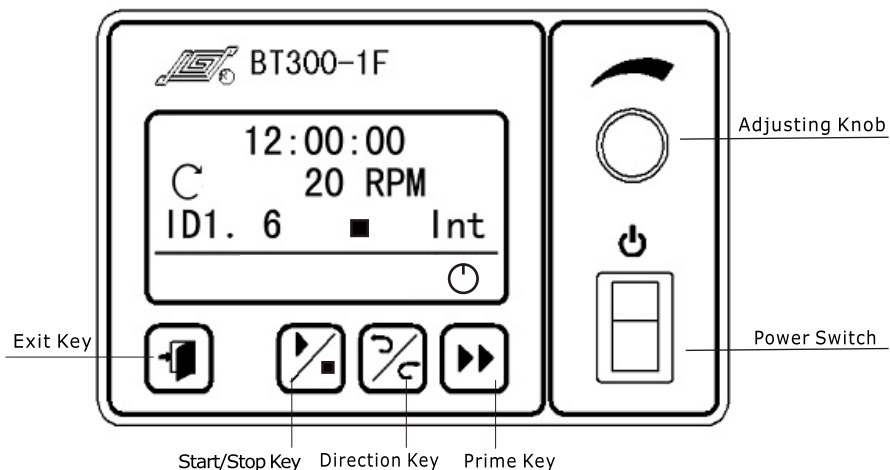

Basic Operation

- **Start/Stop Key**
Press the **Start/Stop Key** to start or stop the pump.
- **Direction Key**
Press the **direction key** to change the rotation direction of the pump.
- **Adjusting Knob**
Function 1: Adjust the flow rates or speed in running state.
Function 2: In menus selection state, press the **Adjusting Knob** for confirmation and turn the **Adjusting Knob** for selecting and setting the menus.
- **Prime Key**
In common state, press the **Prime Key** to enter prime state when the pump runs at full speed for emptying, filling and rinsing operation; Press the **Prime Key** again to return to common state. In prime state, other keys (except **Direction Key**) are invalid.
- **Exit Key**
Cancel current operation and return to previous menu.

Running Interface

Switch on the power switch, initialize the pump first and then display the running interface.

• rpm State

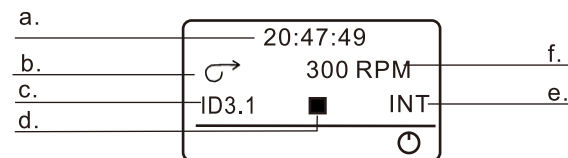

• Flow Rates State

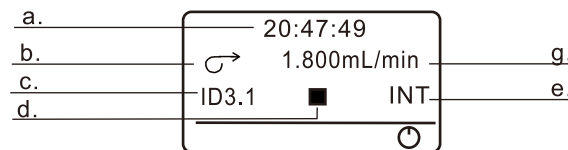

• Filling and Dispensing State

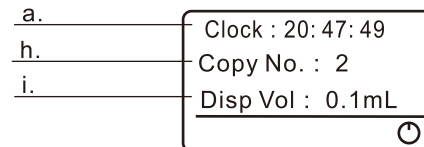

- Clock: Current time. Set in system setting menu.
- Direction: Show the direction of the pump.
- Tubing ID: Display the current tubing inner diameter.
- Start/Stop state: "Start" state displays "▶", "Stop" state displays "■".
- Control Mode: "shut" means remote control is in "off" state. Remote control is in "on" state, "INT" means the pump are controlled by internal control; "V" means the pump are controlled by remote control analog voltage signal; "mA" means the pump are controlled by remote control analog current signal.
- rpm: Display current speed. Turning the **Adjusting Knob** can increase or decrease the speed.
- Flow Rate: Display current flow rate. Turning the **Adjusting Knob** can increase or decrease the flow rate.
- Copy No.: Display copy number in dispensing and filling state.
- Disp Vol: Display filling volume (one time) in dispensing and filling state.

Menu Frame Work

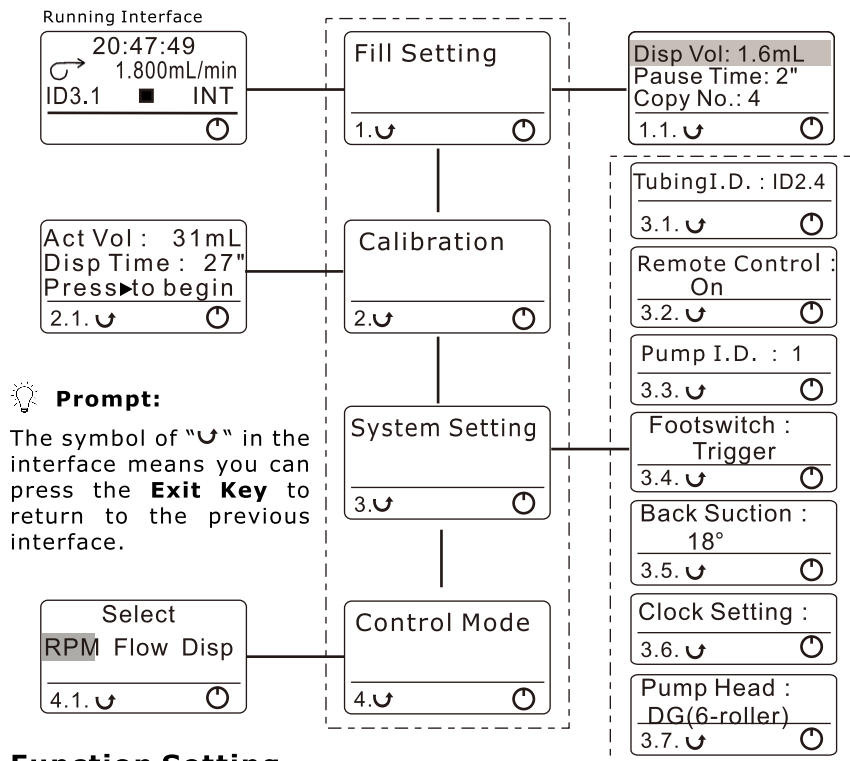

Prompt:
The symbol of "⤵" in the interface means you can press the **Exit Key** to return to the previous interface.

Function Setting

In "Running Interface", press the **Adjusting Knob** to enter "Fill Setting" interface. Turn the **Adjusting Knob** to select 4 kinds of Function Setting Interface.

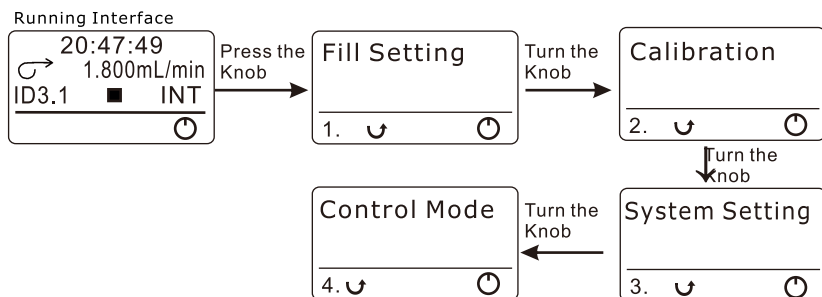

❖ Filling and Dispensing Setting

- Enter "Fill Setting" interface:
 1. Other parameters can't be set here. Set the other parameters first and then go along the "Fill Setting". Other parameters setting methods please see page 8 "System Setting".
 2. In "Running Interface" press the **Adjusting Knob** to enter "Fill Setting" interface. Press the **Adjusting Knob** again to enter filling setting menu. Turn the Adjusting Knob to select parameters. There are 4 parameters. They are Volume, Pause time, Copy No., Flow.

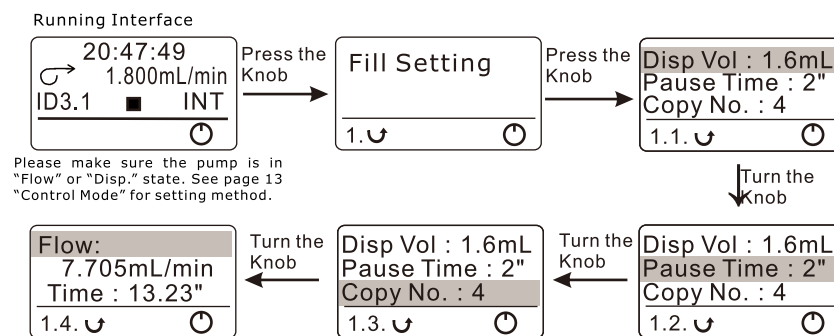

Please make sure the pump is in "Flow" or "Disp." state. See page 13 "Control Mode" for setting method.

- Volume: In "Fill Setting" interface, press the **Adjusting Knob** to enter the next interface. Press the **Adjusting Knob** to enter "Volume" interface. Turn the **Adjusting Knob** to input required volume. Press the **Adjusting Knob** to confirm, save and quit. Press the **Exit Key** to cancel the setting and return to the previous interface.

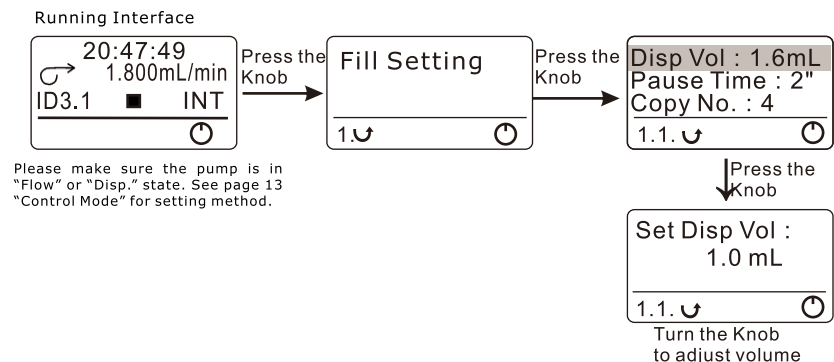

Please make sure the pump is in "Flow" or "Disp." state. See page 13 "Control Mode" for setting method.

- **Pause Time:** The pause time between two filling. Its range is 0.1s to 999s(0.1s resolution within the speed of 1rpm-100rpm, 1s resolution within the speed of 100rpm-300rpm).
In "Fill Setting" interface, press the **Adjusting Knob** to enter the next interface. Turn the **Adjusting Knob** to highlight the "Pause time". Press the **Adjusting Knob** to enter "Pause time" interface. Turn the **Adjusting Knob** to adjust the pause time. Press the **Adjusting Knob** to confirm, save and quit. Press the **Exit Key** to cancel the setting and return to the previous interface.

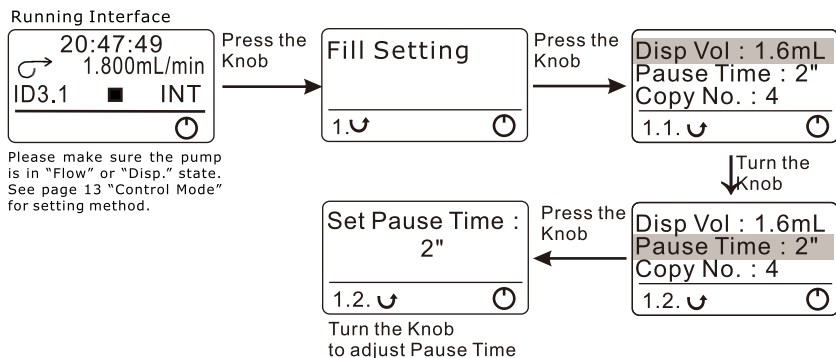

- **Copy No.:** the total filling number. Its range is 1- 999.
In "Fill Setting" interface, press the **Adjusting Knob** to enter the next interface. Turn the **Adjusting Knob** to highlight the "Copy No.". Press the **Adjusting Knob** to enter "Copy No." interface. Turn the **Adjusting Knob** to adjust the copy number. Press the **Adjusting Knob** to confirm, save and quit. Press the **Exit Key** to cancel the setting and return to the previous interface.

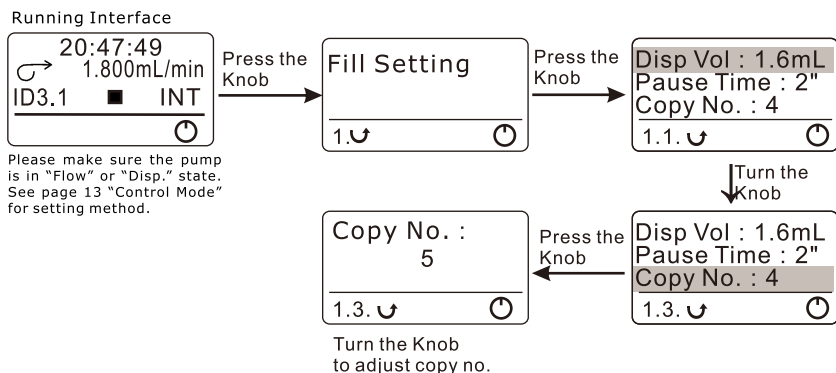

- **Flow:** Adjust the dispensing and filling efficiency. Its range is determined by the pump head and tubing.
In "Fill Setting" interface, press the **Adjusting Knob** to enter the next interface. Turn the **Adjusting Knob** to highlight the "Flow". Press the **Adjusting Knob** to enter "Flow" interface. Turn the **Adjusting Knob** to adjust the flow rate and dispensing time. Press the **Adjusting Knob** to confirm, save and quit. Press the **Exit Key** to cancel the setting and return to the previous interface.
Time: Filling time for one time.

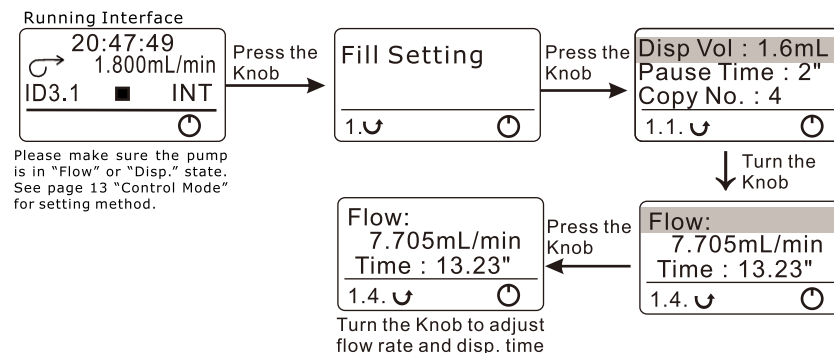

Note:

Change the tubing if can't get the desired filling time.

❖ **Calibration Function**

- Calibration is needed in below situation:
1. Use the pump the first time; 2. Change the pump head; 3. Change the tubing; 4. Setting the new flow rate; 5. Operating condition changes.
- Enter calibration function setting interface:
In "Running Interface", press the **Adjusting Knob** to enter "Fill Setting" interface, turn the **Adjusting Knob** to enter "Calibration" interface.

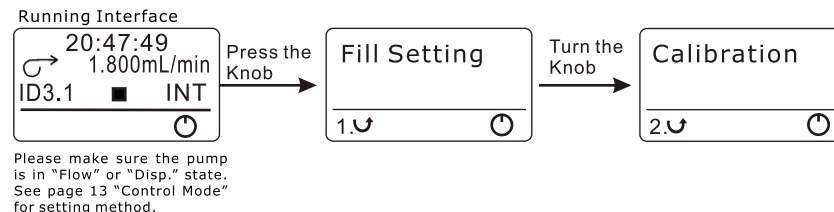

3.2 Remote Control

- Remote Control on or off setting.
On: Remote control is permitted.
Off: Remote control is forbidden.
- In "Remote Control" interface, press the **Adjusting Knob** to enter remoter control setting interface. Turn the **Adjusting Knob** to select the corresponding state. Press the **Adjusting Knob** to save and quit. Press the **Exit Key** to cancel the setting and return to "Remote Control" interface.

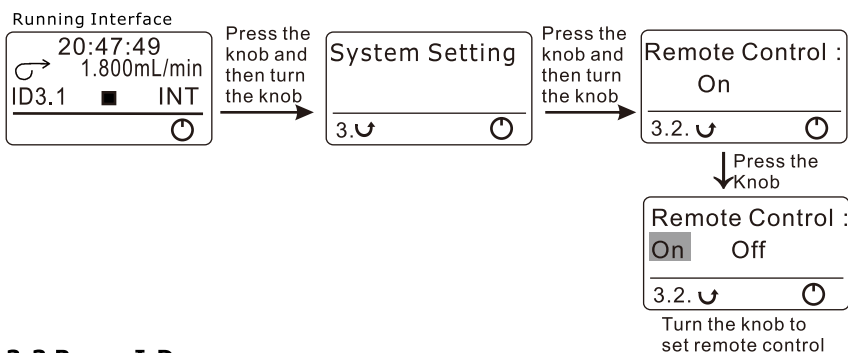

3.3 Pump I.D.

- When control computer controls many pumps through RS485 interface, it must identify each pump's I.D.. This pump I.D. should be unique. It's the identification of this pump.
- In "Pump I.D." interface, press the **Adjusting Knob** to enter pump I.D. setting interface. Turn the **Adjusting Knob** to select the corresponding number (1- 30) . Press the **Adjusting Knob** to save and quit. Press the **Exit Key** to cancel the setting and return to "Pump I.D." Interface.

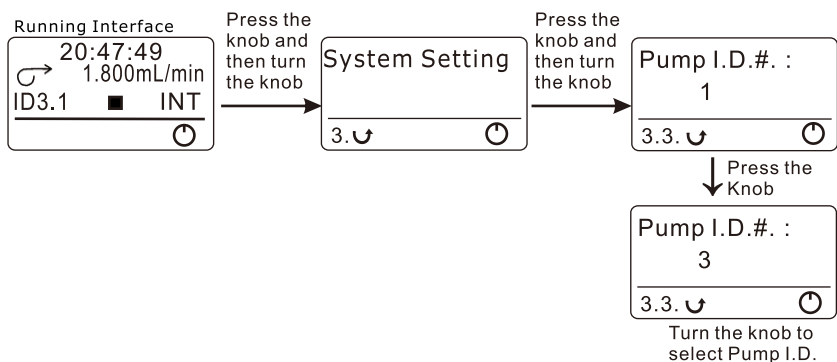

3.4 Footswitch

- Set footswitch working mode.
1. Gated: The pump runs as long as the footswitch is pressed.
2. Trigger: Press footswitch, the pump starts running; Press footswitch again, the pump stops.
- In "Footswitch" interface, press the **Adjusting Knob** to enter footswitch setting interface. Turn the **Adjusting Knob** to select the corresponding state. Press the **Adjusting Knob** to save and quit. Press the **Exit Key** to cancel the setting and return to "Footswitch" interface.

Note:
The pump identifies the Longer Footswitch automatically. When the pump connects the footswitch, the **Start/Stop Key** on operating panel is invalid no matter the remote control is on or off.

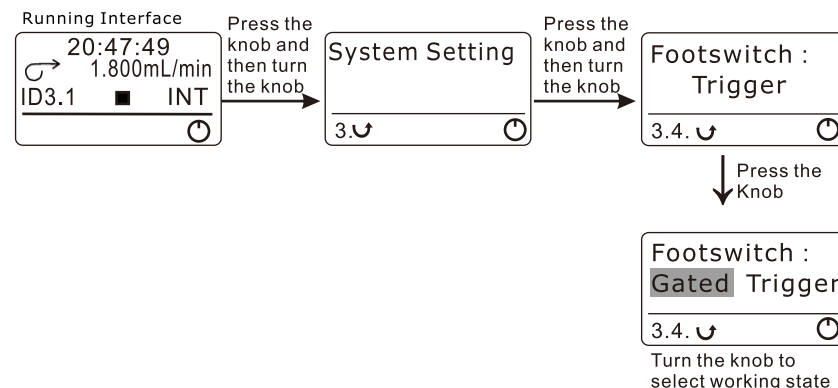

3.5 Back Suction

- In dispensing and filling state, to prevent the liquids drippage to cause error when the filling stops, the pump will back-turn a back suction angle to suck back the liquids. The back suction is the same for each filling operation, it doesn't influence the filling accuracy.
- In "Back Suction" interface, press the **Adjusting Knob** to enter back suction angle setting interface. Turn the **Adjusting Knob** to adjust the back suction angle. Press the **Adjusting Knob** to save and quit. Press the **Exit Key** to cancel the setting and return to "Back Suction" interface.

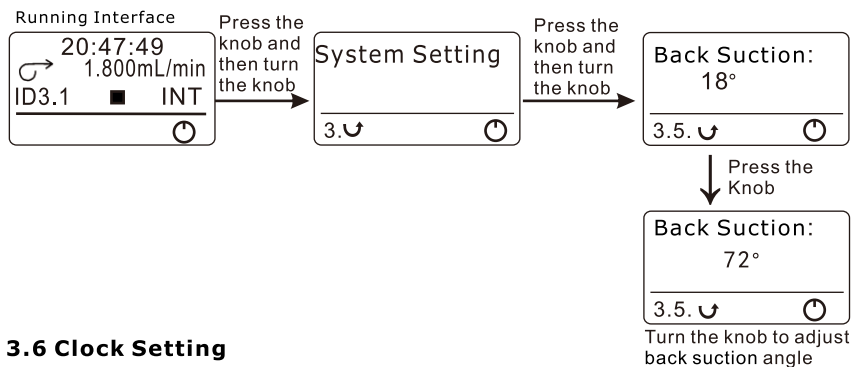

3.6 Clock Setting

- Set the time.
In "Time Setting" interface, press the **Adjusting Knob** to enter time setting interface. Set the hour, minute, second through press and turn the **Adjusting Knob**. Press the **Adjusting Knob** to save and quit. Press the **Exit Key** to cancel the setting and return to "Time Setting" interface.

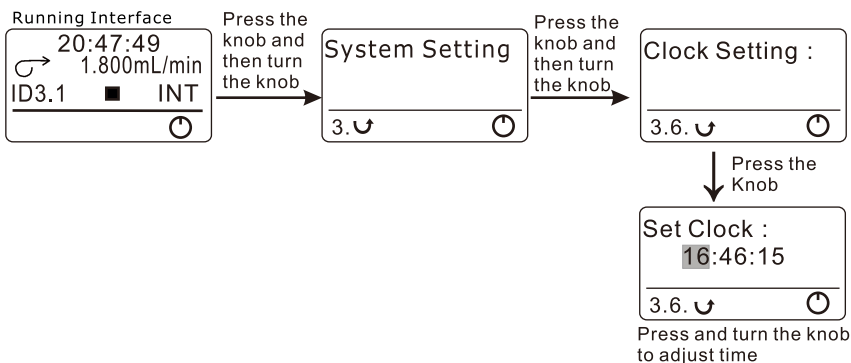

3.7 Pump Head Selection

- Make sure the pump head corresponds to the setting of the menu.
- In "Pump Head" interface, press the **Adjusting Knob** to enter pump head selection setting interface. Turn the **Adjusting Knob** to select the corresponding pump head. Press the **Adjusting Knob** to save and quit. Press the **Exit Key** to cancel the setting and return to "Pump Head" interface.

Note:

After change the pump head, the default tubing is the minimal diameter tubing used for this pump head.

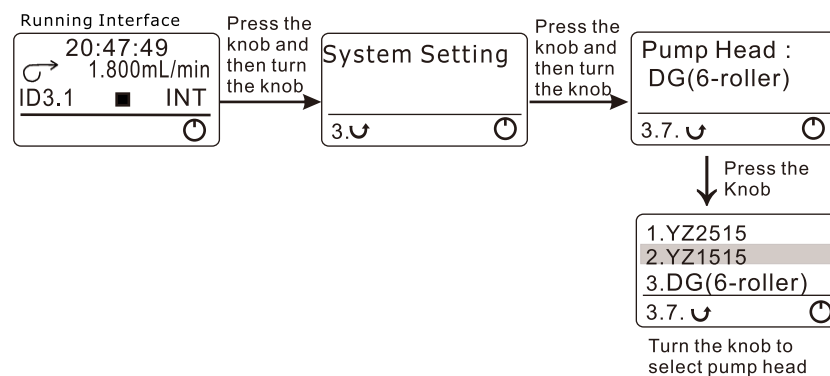



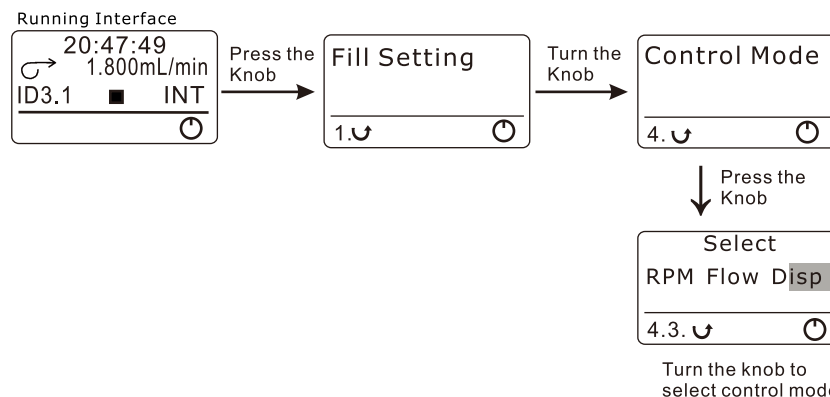

❖ Control Mode

- Set display state of the pump. There are 3 states: rpm, Flow, Disp.
- In "Running Interface", press the **Adjusting Knob** to enter "Fill Setting" interface. Turn the **Adjusting Knob** to enter "Control Mode" interface. Press the **Adjusting Knob** to enter control mode setting interface. Turn the **Adjusting Knob** to select the required control mode. Press the **Adjusting Knob** to save and quit. Press the **Exit Key** to cancel the setting and return to "Control Mode" interface.

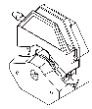

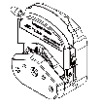
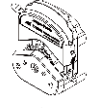
Acceptable Pump Heads and Tubing

Pump Head	Tubing	Flow Rates (mL/min)
 YZ1515	13# 14# 16# 25# 17# 18#	0.07~1140
 YZ1515w	13# 14# 16# 25# 17# 18#	0.07~1140
 YZ1515x	13# 14# 16# 25# 17# 18#	0.07~1140
 YZ2515	15# 24#	1.7~870
 DG-4/6 rollers	Inner Diameter ≤ 2.4 (mm) Wall Thickness ≤ 1.0 (mm)	0.005~30
 DG-4/10 rollers	Inner Diameter ≤ 2.4 (mm) Wall Thickness ≤ 1.0 (mm)	0.005~20

Pump Head Mounting

The pump head is mounted on drive before the pump leaves the factory. Follow below procedure for changing another pump head.

1. Loose the two M4 screws which connect the pump head and the drive. Dismantle the pump head slightly.
2. Insert the flat end of the pump head's shaft to the slot of drive's coupling. Make the location hole of the pump head match the location pin of the drive.
3. Insert the two mounting screws into the mounting holes of the pump head. Then tighten the mounting screws to connecting hole of drive.



Note:

Shut off the power supply before changing the pump head.

Remote Control

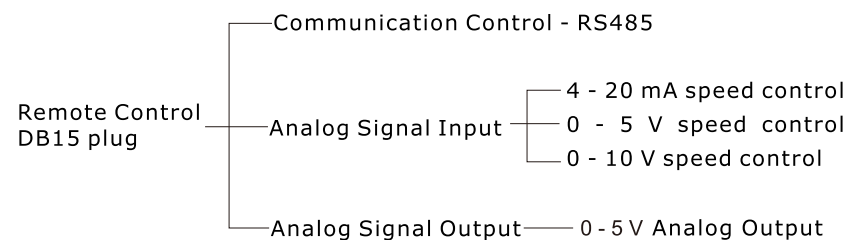

❖ **Communication Control**

The pump can connect to control computer (computer, PLC, SCM) through RS485 serial communication module (shown as below). Please contact Longer Company for communication protocol.

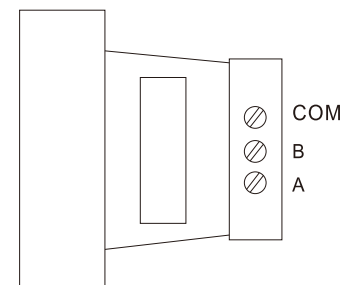

❖ **Analog Signal Input Function**

Set the "Remote Control" in "on" state. External Control Module is shown as below.

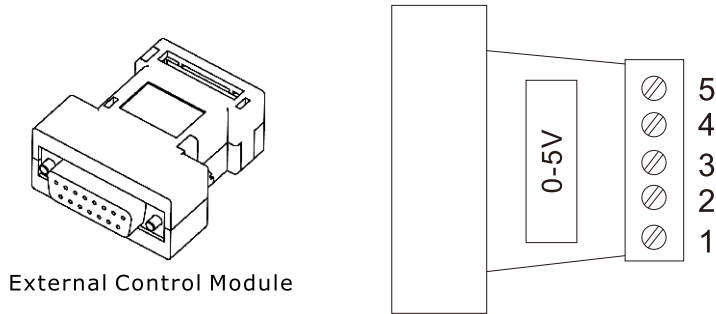

External Control Module



Note:

Four kinds of standard external control module need to order separately according to special requirements.

• Terminal Definition of Standard External Control Module

1# Analog speed control input, for external speed control in external control modules of 4 to 20 mA, 0 to 5V and 0 to 10 V.

2# External start/stop control input. When connected to COM, the pump runs, when connected to high level (5 - 12 V), the pump stops.

3# External cw/ccw control input. When connected to COM, the pump rotates cw, when connected to high level (5 - 12 V), the pump rotates ccw.

4# Reference potential for 4 to 20 mA, 0 to 5V/10V speed control input.

5# Reference potential for external cw/ccw, external start/stop input.

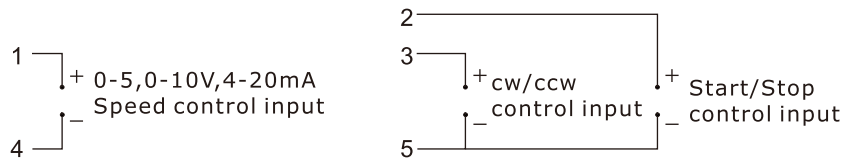

0 - 5V, 0 - 10V, 4 - 20mA External Control Module Wiring Diagram

❖ **Analog Signal Output Function**

Standard remote control module is shown as below. Output signal includes cw/ccw output, start/stop output, 0 - 5V voltage output. One side of the module is DB15 plug. Another side is wiring terminal. Insert the corresponding standard remote control module into the DB15 socket which is in the rear of the pump to get corresponding output signal. The location of the terminal is shown as below. The terminal which hasn't signal output is open.

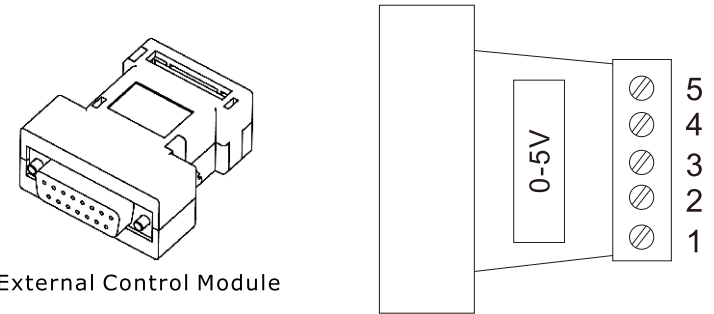

External Control Module

• Terminal Definition of Standard External Control Module

1# 0- 5V analog output terminal.

2# Start/Stop signal output terminal. When the pump runs, the output is high level; when the pump stops, the output is low level.

3# CW/CCW signal output terminal. When the pump turns clockwise, the output is high level; when the pump turns counter clockwise, the output is low level.

4# Reference potential for 0 - 5V analog output.

5# Reference potential for start/stop and cw/ccw output.

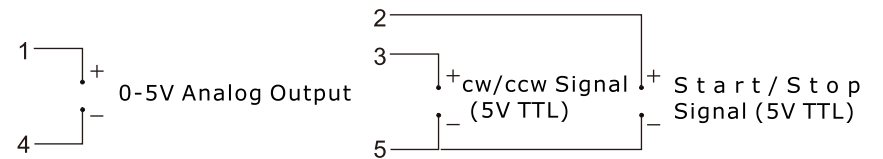

0 - 5V Signal Output Module Wiring Diagram



Note:

Standard external control module needs order separately.

Optional Accessory

❖ **Footswitch**

Connect to the external control interface. Control the start and stop of the pump.

 **Note:**

Footswitch is optional accessories. It can only control the start and stop of the pump. The speed and direction of the pump are controlled by the knob and switch on the operation panel.

Communication Function

BT300-1F can connect to the control computer (computer, PLC, SCM) through RS485 serial communication interface.

 **Note:**

1. The I.D. of the pump which connects to the control computer through RS485 serial communication interface must be unique to prevent the communication from error.
2. Please contact Longer Company for communication protocol.

Maintenance

- When the pump is idle, we recommend you to release the tubing from pressure. This helps to protect the tubing from unnecessary strain and prolongs its service life
- Keep rollers clean and dry. This will prolong the service lives of tubing and pump head.
- The surface of drive and the pump head are not organic solvent and aggressive liquids resistant. Please pay attention when using.

 **Note**

If a trouble happens, please contact us or our dealers.

Warranty

The warranty period for this product is one year. If repair or adjustment is necessary within the warranty period, the problem will be corrected at no charge if it is not due to misuse or abuse on your part, as determined by the manufacturer. Repair costs outside the warranty period, or those resulting from product misuse or abuse, may be invoiced to you.

Technical Specifications

❖ **Functions**

Applicable Pump Head: DG Series (DG-1, DG-2, DG-4), YZ Series
Flow Rate Adjustment: Realize accurate flow rate adjustment function
Flow Rate Calibration: Calibrate the setting flow rate to get accurate flow rate
Speed Control: Realize accurate speed control through rotary coded switch
Display: 128*64 graphic LCD displays current running status
Prime: For fast filling and emptying
Direction Control: cw and ccw reversible
External Control: Start/stop control, direction control, speed control (0 - 5V, 0 - 10V, 4 - 20mA optional)
Communication Function: RS485, Baud rate: 1200 bps
Dispensing and Filling Function: Set dispense volume, copy number, pause time and back suction angle
Memory Function: Storing the running parameter automatically
Cooling Mode: Heat-emitting fan

❖ **Specifications**

Speed: 1- 300rpm, reversible
Speed Precision: 1 rpm
Adjusting Mode: Continuous rotary coded switch adjustment
Display Mode: 128*64 graphic LCD display. Display can switch between flow rate, speed and filling.
Applicable Power: AC 220V +/- 10% 60Hz+/-1Hz AC 110V +/- 10% 60Hz+/-1Hz
Power Consumption: < 60 W
Operating Condition: Temperature 0 to 40°C Relative humidity < 80%
Drive Dimensions (L x W x H): 240 x 155 x 171 (mm)
Drive Weights: 4.3 Kg
IP Rating: IP 31